

BASIC SCIENCE

Part - 2

Standard VIII



**Government of Kerala
Department of Education**

**State Council of Educational Research and Training (SCERT), KERALA
2016**

The National Anthem

Jana-gana-mana adhinayaka, jaya he
Bharatha-bhagya-vidhata.
Punjab-Sindh-Gujarat-Maratha
Dravida-Utkala-Banga
Vindhya-Himachala-Yamuna-Ganga
Uchchala-Jaladhi-taranga
Tava subha name jage,
Tava subha asisa mage,
Gahe tava jaya gatha.
Jana-gana-mangala-dayaka jaya he
Bharatha-bhagya-vidhata.
Jaya he, jaya he, jaya he,
Jaya jaya jaya, jaya he!

PLEDGE

India is my country. All Indians are my brothers and sisters.

I love my country, and I am proud of its rich and varied heritage. I shall always strive to be worthy of it.

I shall give respect to my parents, teachers and all elders and treat everyone with courtesy.

I pledge my devotion to my country and my people. In their well-being and prosperity alone lies my happiness.

State Council of Educational Research and Training (SCERT)

Poojappura, Thiruvananthapuram 695012, Kerala

Website : www.scertkerala.gov.in, e-mail : scertkerala@gmail.com

Phone : 0471 - 2341883, Fax : 0471 - 2341869

Typesetting and Layout : SCERT

First Edition : 2015, Reprint : 2016

Printed at : KBPS, Kakkanad, Kochi-30

Dear students,

You were provided with opportunities to observe your surroundings and engage in simple experiments and investigative activities in earlier classes. The classroom experience, undoubtedly, might have helped you to record the information systematically and assimilate ideas through discussion and analysis. While understanding the scientific approach, there should also be the attitude to take forward the skills to apply them in day-to-day life. Moreover, an eco-friendly perspective must be adopted too. All these, through direct experiences, enquiry and understanding preferably.

This textbook presents ideas in accordance with this. There are experiments, illustrations and explanatory details that enable the comprehension of these ideas. There are opportunities appropriate to the situation to make learning more enjoyable.

Go ahead, thinking, asking questions, approaching ideas critically and quizzing with teachers and friends.

Make learning a joyful experience.

Regards,

Dr. J. Prasad
Director, SCERT

TEXTBOOK DEVELOPMENT TEAM

Emerson F

GGHS, Chavara, Kollam

Satheesh. R

GHSS Anchal West, Kollam

Shajil. U.K

GGHSS, Balussery, Kozhikode

Nisar Ahamed M

GHSS Venjarammood, Trivandrum

Rasheed Odakkal

GVHSS Kondotti, Malappuram

Vineesh T.V

GHS Chenad, Wayanad

P.D. Baby

St. Antony's HSS, Mutholi, Pala

Gopalan N.K

HSA (Retd), KKMGVHSS Vadakara

Unnikrishnan T.I

Headmaster (Retd), AKKRHS for Boys, Kozhikode

Pradeepkumar K.V

Moothedath HSS, Taliparamba, Kannur

Premachandran K.V

GHSS Maniyoor, Vadakara, Kozhikode

Sajikumar K.G

GV & HSS for Girls, Manacaud, Trivandrum

Sureshkumar K

AMHSS, Thirumala, Trivandrum

Babu Payyath

BPO, BRC, Kozhikode

Muhammed Abdul Nazar

Master Trainer, IT @ School

Santhoshkumar V.G

BYKVHSS, Valavanoor, Malappuram

Dr. Vishnu V.S

Asst. Prof., College of Engineering, Trivandrum

Sadanandan C

Pantheerankave HSS, Kozhikode

Muhammed Rafi C.

Govt. Technical HS, Naruvambram, Kannur

Shabu Ismail

PMSAVHSS Chappanangadi, Malappuram

K.T.Manoj

CBHSS Vallikkunnu, Malappuram

Hasan C.C

MMVHSS Parappil, Kozhikode

Preethi K.A

SHS Mannarkadu, Palakkad

EXPERTS

Prof. Sivasankara Pillai

Head (Rtd.), Dept. of Physics,
Women's College, Trivandrum

Dr. S Mohanan

Reader & Head (Rtd.), Dept. of Physics,
University College, Trivandrum

Paul P I

Associate Prof., Dept. of Zoology, Mar Ivanios
College, Trivandrum

Dr Alaudeen M

Principal (Rtd.) Govt. College, Elerithattu

Sebastian Lukose T.J

Sel. Grade Lecturer (Rtd.), University College,
Trivandrum

Dr. N Ratheesh

Asst. Professor, SN College, Kollam

ENGLISH VERSION

Dr. Saji Mathew

Asst. Professor, School of Letters,
M.G University

Famila E R

HSST, GHSS, Karunagappally

Anil M R

Govt. GHSS, Karamana, Trivandrum

Dr Subash Babu K

Deputy Director
Collegiate Education, Trivandrum

ARTISTS

Musthajib E C

MMETHS, Melmuri

Noushad Vellalasseri

Ganapath AUPS, Keezhisseri

Muhammed Shameem

VAUPS, Kavanoor

Lohithakshan K

Assisi School for the Deaf, Malapparambu

Viswanathan P

DDE Office, Malappuram

Academic Co-ordinator

Dr. Ancey Varughese

Research Officer, SCERT

Contents



- 12. Why Classification? 167
- 13. Diversity for Sustenance 181
- 14. For the Continuity of Generations 197

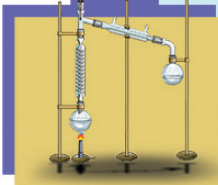

- 15. Solutions 213
- 16. Water 224
- 17. Fibres and Plastics 237

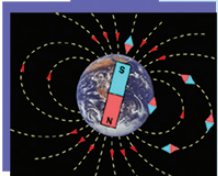

- 18. Reflection of Light in Spherical Mirrors 246
- 19. Sound 262
- 20. Static Electricity 276

Certain icons are used in this
textbook for convenience



*For further reading
(Evaluation not required)*



*ICT possibilities for making
concepts clear*



Significant learning outcomes



Let us assess



Extended activities

Why Classification?



Did you notice the opinion of the girl searching for a book?
What are the advantages of arranging books in proper order?
Haven't you noticed the arrangement of books in a library?
In what all ways books may be arranged? Discuss.

-
-

Things need to be classified first in order to arrange them properly. Aren't the things in your study room and kitchen arranged according to their types?

Human beings show a tendency to classify things around them. What are the bases for such classification?

- Shape
- Colour
- Size
- Use
-

Observe the figures.

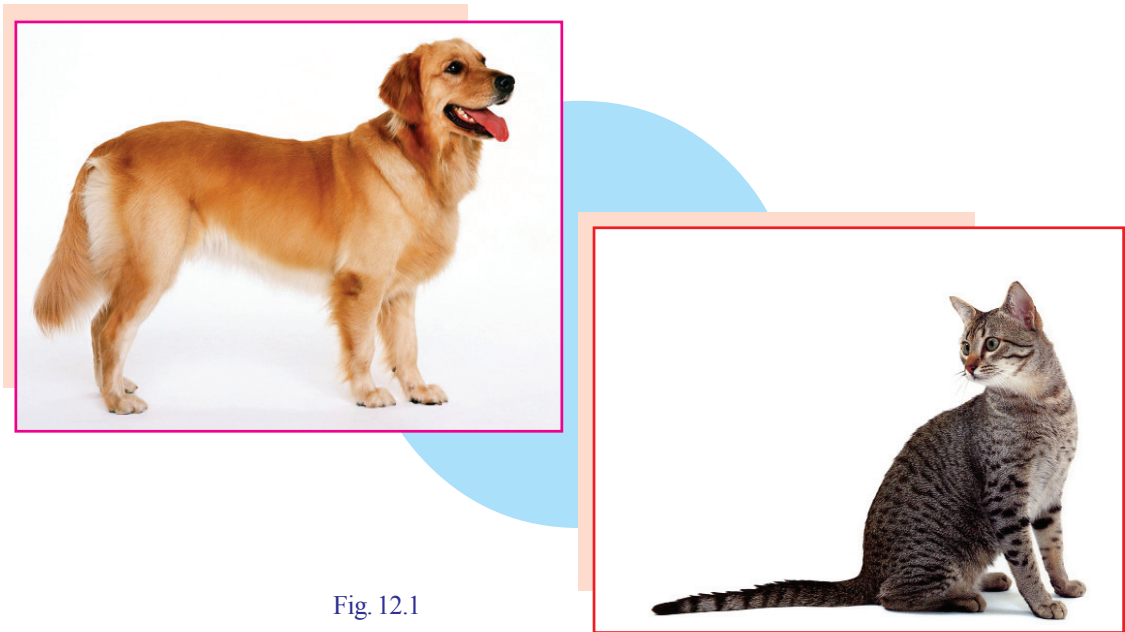

Fig. 12.1

What criteria can be used for classifying these organisms?

- size
- beauty
- speed
- sharp incisors
- claws that can be withdrawn into the feet
-

Which among these criteria is the most suitable one for classification? Why? Discuss.

If more specific criteria are adopted, classification becomes more accurate.

It will be easy to study organisms if they can be classified according to suitable criteria.

Let's classify and learn

Observe the illustration given below.

Do you know all the peculiarities of the organisms shown in the illustration?

Notice the classification of these organisms on the basis of certain observable characteristics. Analyse the criteria used for classification.

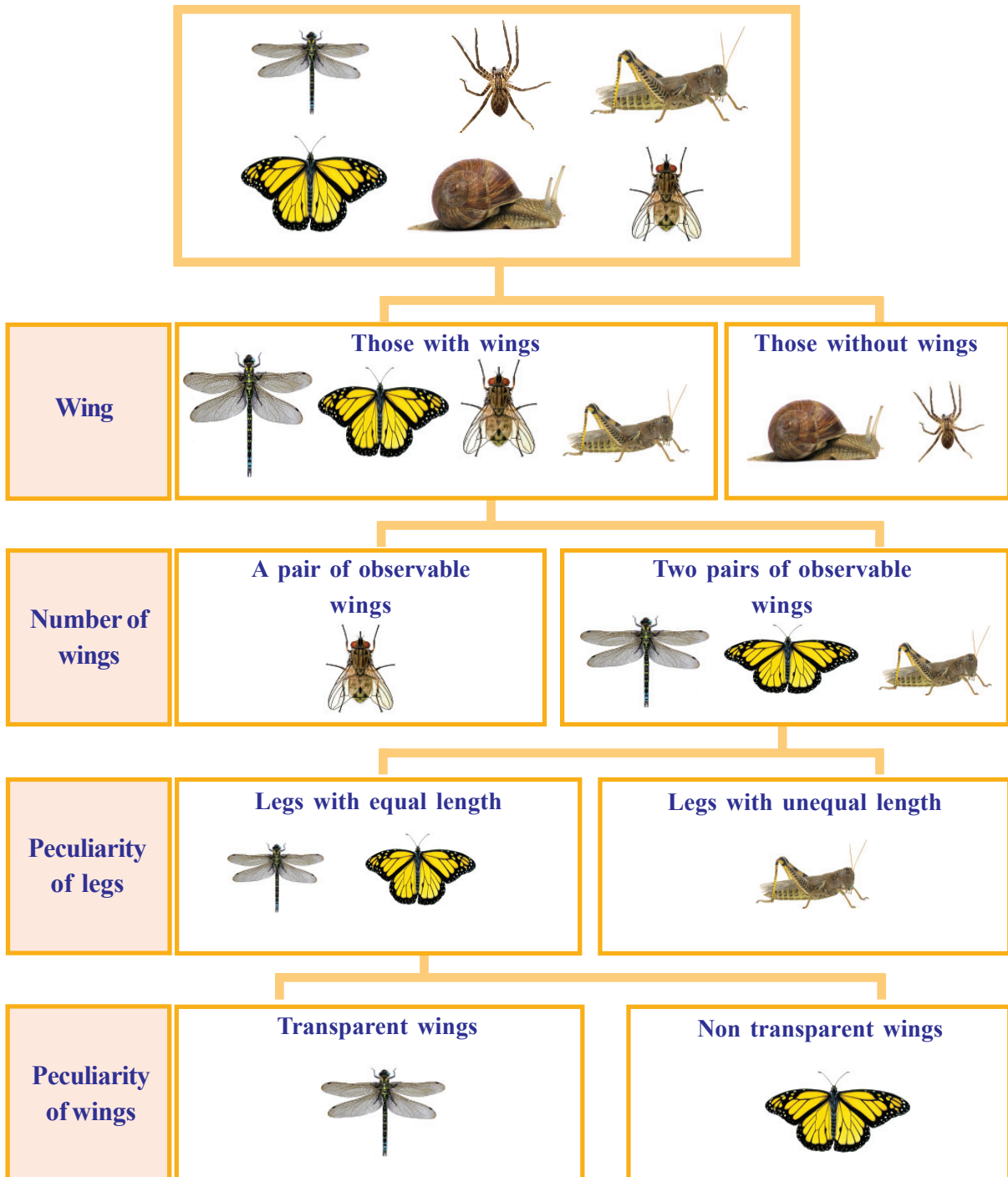

Illustration 12.1

Why is the classification of these organisms very easy?

- Less number of organisms
- Specific indicators
- Two clear options for each indicator

Classification becomes easier with the use of such specific indicators.

Analyse with the help of the indicators the note given below and write down the inferences in the science diary.

Keys for identification

Taxonomic keys are the scientific indicators used for identifying and classifying plants and animals. One of the most important taxonomic keys is the dichotomous key.

Each indicator in this key has two possibilities of selection. By choosing the peculiarities of the organism to be identified and by proceeding systematically one can identify and classify the organism. Illustration 12.1 is a dichotomous key. The taxonomic keys are continuously revised by including peculiarities of newly identified organisms.

Indicators

- Taxonomic keys
- Peculiarity of dichotomous keys

Thus, the method of classification is the act of grouping of organisms based on similarities or differences.

Taxonomy

Taxonomy is the branch of biology that identifies organisms, classifies them on the basis of similarities and differences and names them scientifically. For the purpose of classification, the characteristic features of organisms, their external and internal features, genetic constitution, evolutionary relationships etc., are to be thoroughly studied. This study reveals the relation between various groups of organisms. It also enables us to acquire a general idea about the plants and animals of various geographical areas. Moreover, taxonomy provides evidences that are helpful to explain the stages of evolution of organisms from the simple to the complex.

Based on similarities or differences, all organisms including human beings are placed in different levels of classification. It was a scientist named Carl Linnaeus who fixed taxonomic hierarchy and provided a scientific base for classification. Hence he is known as the Father of Taxonomy.

Let's familiarise ourselves with some scientists who have made valuable contributions in the history of taxonomy.

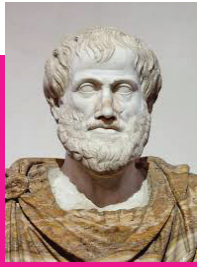

Aristotle (Greece)
The Father of Biology. He classified organisms as those with red blood cells and those without red blood cells.
(B.C. 384-322)



Theophrastus (Greece)
The Father of Botany. He classified plants into annuals, biennials and perennials.
(B.C. 371-287)

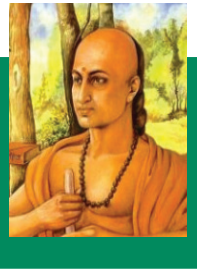

Charakan (India)
The Father of Ayurveda. He wrote the treatise *Charaka Samhita* by including in it around 200 plants and animals.
A.D. 1st century

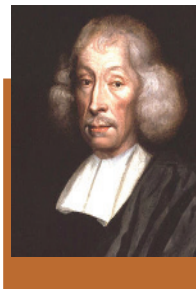

John Ray (England)
Recorded more than 18000 plants in the book '*Historia Generalis Plantarum*'. Used the term 'species' for the first time.
(A.D. 1627-1705)

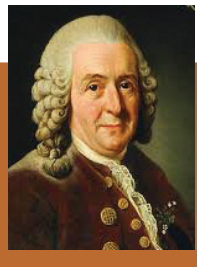

Carl Linnaeus (Sweden)
The Father of Modern Taxonomy. Suggested the taxonomic hierarchy. Proposed binomial nomenclature, the scientific naming method for organisms.
(AD. 1707-1778)

Taxonomic hierarchy proposed by Linnaeus

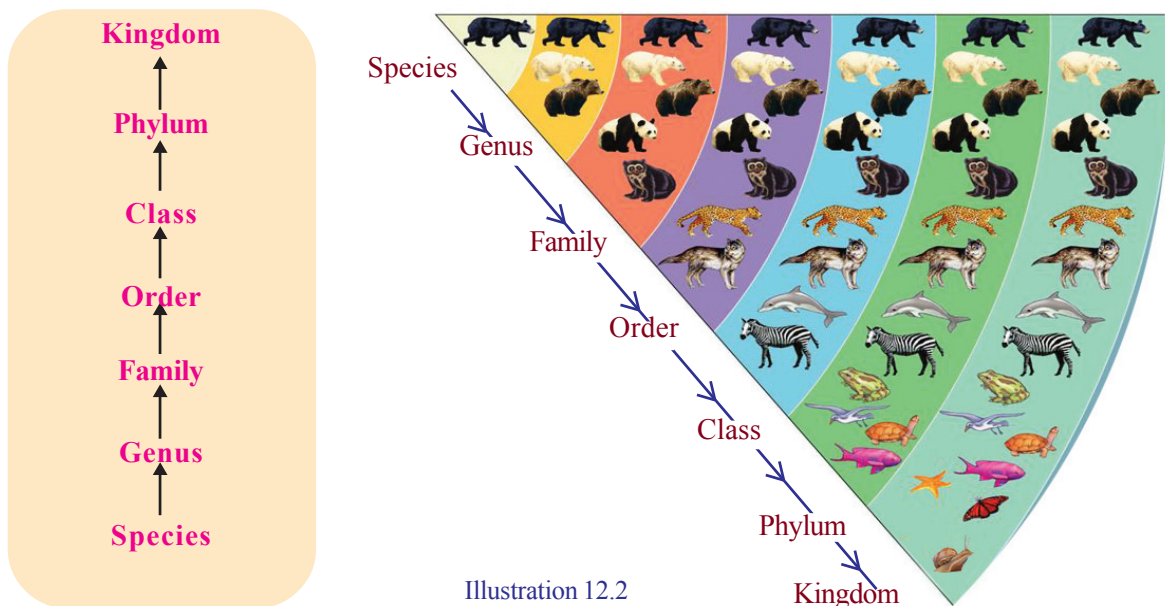

Illustration 12.2

According to biological definition, species is a group of organisms that can produce fertile offsprings through sexual reproduction. Species is the basic level of classification. Organisms of a species share maximum similarity of features. Organisms of similar species constitute the genus. Similar genus constitute the family and families join to form the order. Various orders constitute the class. Related classes join to form phylum. All phyla constitute the kingdom, which is the highest level.

Observe the illustration given below and discuss it on the basis of the indicators. Write down your inferences in the science diary.

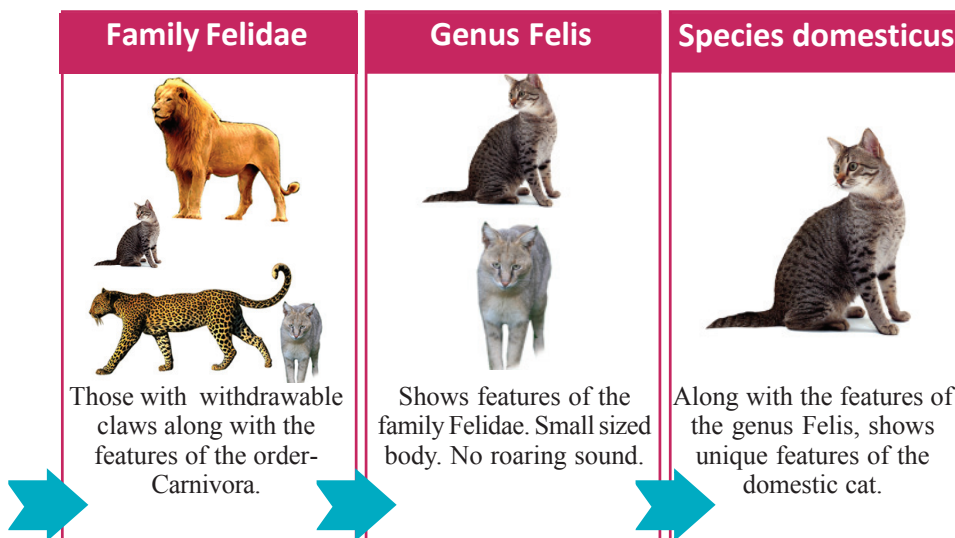
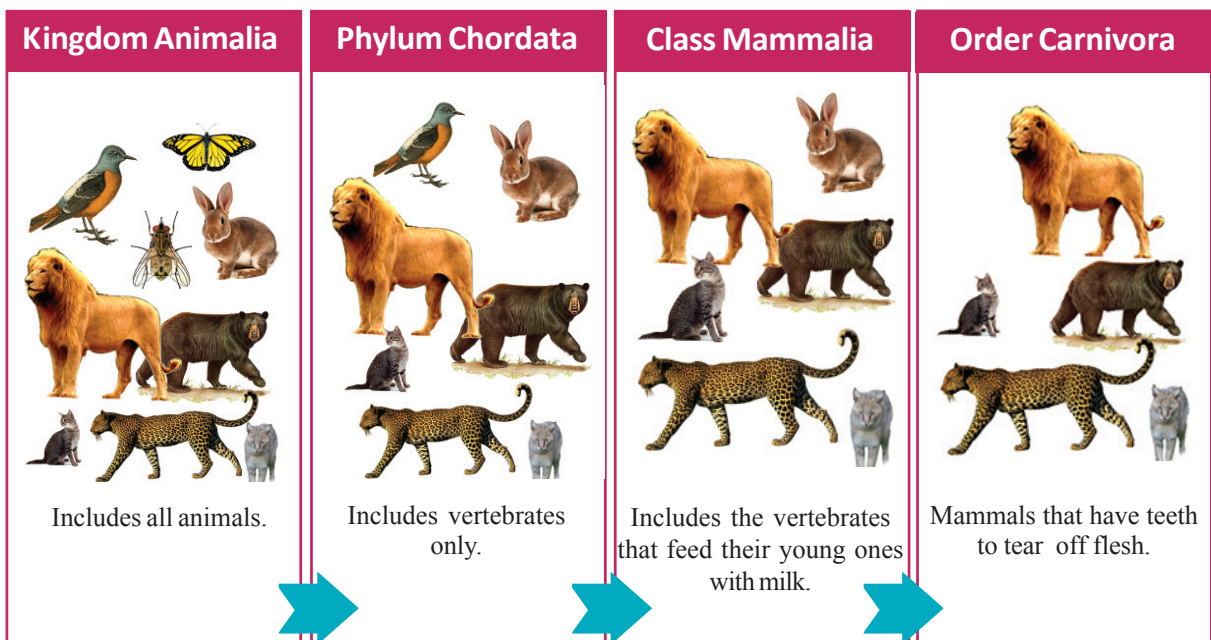

Illustration 12.3

Indicators

- Which are the organisms included in kingdom Animalia?
- Which organisms are excluded at each consecutive levels? Why?
- At what levels of this illustration can humans be included?

Complete the worksheet identifying the levels of classification of cat.

Kingdom	- - - - -
Phylum	- - - - -
Class	- - - - -
Order	- - - - -
Family	- - - - -
Genus	- - - - -
Species	- - - - -



Hortus Malabaricus



Hortus Malabaricus (Garden of Malabar) is the first book on Kerala's plant wealth. This book was published in 12 volumes from Amsterdam in the Netherlands during the years 1678 to 1693. The book was written under the leadership of Admiral Van Rheede, the Cochin Governor of Dutch East India Company. Great native scholars like Kollattu Itti Achuthan Vaidyar, Ranga Bhat, Vinayak Pandit and Appu Bhat made remarkable contributions in the writing of the book. Malayalam fonts were used for the first time for this book in which classification of plants, pictures and local names are recorded. This was one of the books that greatly influenced Carl Linnaeus.

Taxonomic hierarchy of plants

Linnaeus also classified plants by including them in various levels from species to kingdom. Though revised in course of time, these are still used as the basic levels of classification.



Kingdom – Plantae
 Phylum – Angiospermophyta
 Class – Monocotyledonae
 Series – Calycinae
 Family – Arecaceae
 Genus – Cocos
 Species – nucifera



Kingdom – Plantae
 Phylum – Angiospermophyta
 Class – Dicotyledonae
 Series – Sapindales
 Family – Anacardiaceae
 Genus – Mangifera
 Species – indica

Find out more examples of the classification of plants and write them down in the science diary.

Diversity in names

Notice the organisms given in the picture and their names in different areas.



*Uppan, Chemboth,
Chakoram*



*Vatta, Podukanni,
Uputhi*



*Papaya, Kaplanga,
Karamusa, Omakka*



*Pazhuthara, Karinkanni,
Kalkunnan, Chethumbooram*

Fig. 12.2

If an organism has so many names in a single language, how much will be the diversity when their names in other languages are also considered! Is the presence of different names a hindrance to their study?

Discuss.

Binomial nomenclature

Binomial nomenclature was proposed to solve the difficulties arising out of an organism being known by various names in different languages and regions. This is a commonly accepted scientific method of naming. Binomial nomenclature is the scientific method of naming by joining two words.

It was Carl Linnaeus who proposed binomial nomenclature. The first word of the scientific name indicates the genus and the second word indicates the species. By this method the scientific name of an organism is the same all over the world. According to this, the scientific name of human beings is *Homo sapiens*.

Complete the table given below appropriately, finding out the scientific names of various organisms. Expand the table by including the names of more organisms.

Organism	Scientific name
Elephant	
Peacock	
Dog	
Hibiscus	
Neem	
Paddy	

Table 12.1



Cassia fistula



Corvus splendens



Bos taurus

Towards more precision

According to the two kingdom classification that was prevalent earlier, organisms were classified under two large categories namely, Kingdom Plantae (plants) and Kingdom Animalia (animals).

In the light of the knowledge gained later on the diversity of species, an American botanist Robert H. Whittaker classified organisms into five kingdoms.



Robert H. Whittaker
(1920-1980)

Fig. 12.3

Five kingdom classification

Kingdom	Some organisms included in the kingdom	Peculiarities
Monera	Bacteria	Unicellular organisms without nucleus
Protista	Amoeba	Unicellular organisms with a nucleus
Fungi	Mushrooms	Non-motile, heterotrophic unicellular/multicellular organisms
Plantae	Plants	Autotrophic, multicellular, non-motile organisms.
Animalia	Animals	Heterotrophic multicellular organisms that have the capacity of locomotion.

Table 12.2

Modern trends in taxonomy

In the past, knowledge of the peculiarities of microorganisms like bacteria was limited. Later, it was found out that the archaebacteria belonging to the Kingdom Monera are different from other bacteria in cell structure and physiological functions. Then kingdom Monera was further divided into two Kingdoms; namely archaea and bacteria. Besides this, one more level of classification named domain was added above the kingdom. It was the American scientist Carl Woese who proposed this six kingdom classification.



Fig. 12.4
Carl Woese
(1928-2012)

Analyse the illustration given below with the help of the indicators. Discuss it and write down your inferences in the science diary.

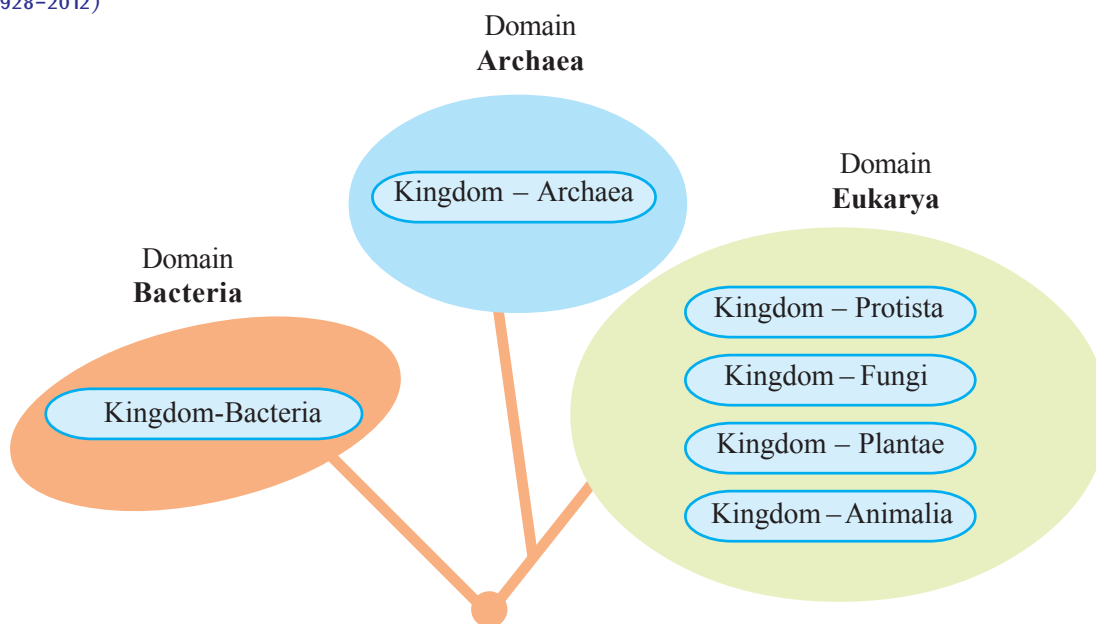

Illustration 12.4

Indicators

- Limitations of two kingdom classification.
- Possibilities of five kingdom classification.
- Circumstances that led to the formulation of six kingdom classification.

Find out the various levels of classification of human beings based on the six kingdom classification and complete the table suitably.



Domain	Eukarya
Kingdom	
Phylum	
Class	
Order	Primates
Family	Hominidae
Genus	
Species	

Table 12.3

Read the newspaper report.

Ebola casting death

New Delhi : The world under the threat of Ebola! According to WHO reports, a total of 9208 have died of Ebola. The illness is caused by Ebola virus

Why is it difficult to control diseases like Ebola ?

Read the description on virus. Discuss with the help of the indicators and write down the inferences in the science diary.

Catch me if you can!

Acellular. With only protein coat and the genetic material. I am a pathogen- causative organism of many dreaded diseases. I can't be destroyed easily. I can only live inside a live cell. I am inactive outside the cell. When I enter the host cell, I multiply using the materials there. I multiply rapidly and destroy that cell. Then I enter new cells. Our world is a world full of mysteries.

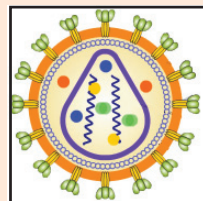

H.I.V

Indicators

- What are the peculiarities of virus?
- Can virus be included in any of the classification methods we have discussed earlier? Why?

No attempts at classification can be perfect and complete. The attempts still continue. The fact is that the more acceptable ones gain general approval.

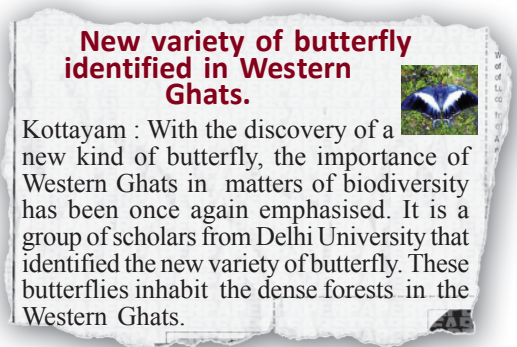

How do we ensure that the organisms mentioned in such reports have never been identified ?

Based on the given indicators, discuss and write down the inferences in the science diary.

- Observation of peculiarities
- Verification of details
- Use of taxonomic keys
- Scientific naming
- Classification

There are millions of unidentified organisms on Earth. The scientific world accepts newly identified organisms by classifying them on the basis of their peculiarities and name them scientifically. Researchers all over the world continue their search for new organisms.



Significant learning outcomes

The learner can

- identify and explain the significance and importance of taxonomy.
- prepare notes on scientists who have contributed to the field of taxonomy.
- list the peculiarities of organisms by identifying the relevance of classification.
- explain the relevance of naming organisms according to binomial nomenclature.
- identify, list and exhibit the scientific names of familiar organisms.
- compare and explain modern trends in taxonomy and various methods of classification.
- list the peculiarities of virus.



Let us assess

1. Identify the word pair relation and fill in the blanks.
 - a. Five kingdom classification : Robert H. Whittaker
Six kingdom classification :
 - b. Charaka : Charaka Samhita
John Ray :
2. Hints about some organisms are given below. Name the kingdom to which these organisms belong:
 - a. Multicellular heterotrophic organisms with a nucleus and capacity for locomotion.
 - b. Multicellular, heterotrophic, non-motile organisms with a nucleus.
 - c. Unicellular organisms with a nucleus.
 - d. Multicellular, autotrophic, non-motile organisms with a nucleus.

3. Write from the table the name of the organism which has more resemblances with tiger. Give explanations for your answer.

Common name	Scientific name
Tiger	<i>Panthera tigris</i>
Wolf	<i>Canis lupus</i>
Lion	<i>Panthera leo</i>
Cat	<i>Felis domesticus</i>
Dog	<i>Canis familiaris</i>



Extended activities

1. Prepare and exhibit labels showing the scientific name and local name of plants in your school premises.
2. Prepare a collage including pictures and notes of animals belonging to Class Mammalia.
3. From being correct to precision is the way of scientific method. Organise a discussion on this topic exemplifying taxonomy.



Unit
13

Diversity for Sustenance

Diversity of organisms adds charm to nature. Life forms are diverse, but no organism in nature exists in isolation.

Observe the illustration and find out examples for the interdependence of organisms.



Biosphere

Biosphere is the part of earth where life exists. It extends to soil, atmosphere and water.



Abiotic factors are also essential for the existence of the living world which comprises of animals, plants and microorganisms. How are abiotic factors useful to biotic factors?

Discuss and complete the illustration given below suitably.

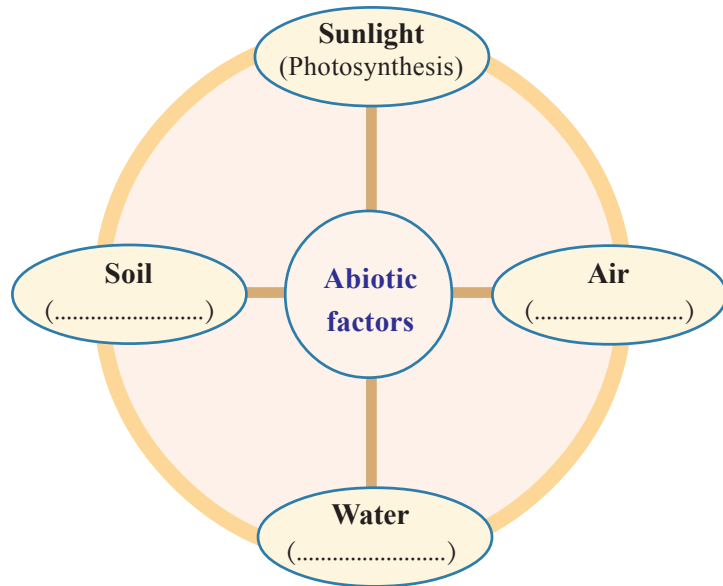

Illustration 13.1

Sun is the primary source of energy in the living world. Green plants convert light energy to chemical energy through photosynthesis.

This energy gets transferred to other organisms through food chain. Plants that perform photosynthesis are called **producers** while organisms that depend on plants directly or indirectly for food are called **consumers**. The consumers that directly depend on plants are called primary consumers. Organisms that feed on primary consumers are called secondary consumers. Organisms that feed on secondary consumers are called tertiary consumers.

You are already familiar with the food web that illustrates food relations in nature.

Observe the illustration of a food web.

With the help of the indicators, discuss and write down the inferences.

Ecology

Ecology is the study of interaction between organisms and also between the organisms and their surroundings. This branch of study includes different types of ecosystems, interaction between organisms, environment protection etc.

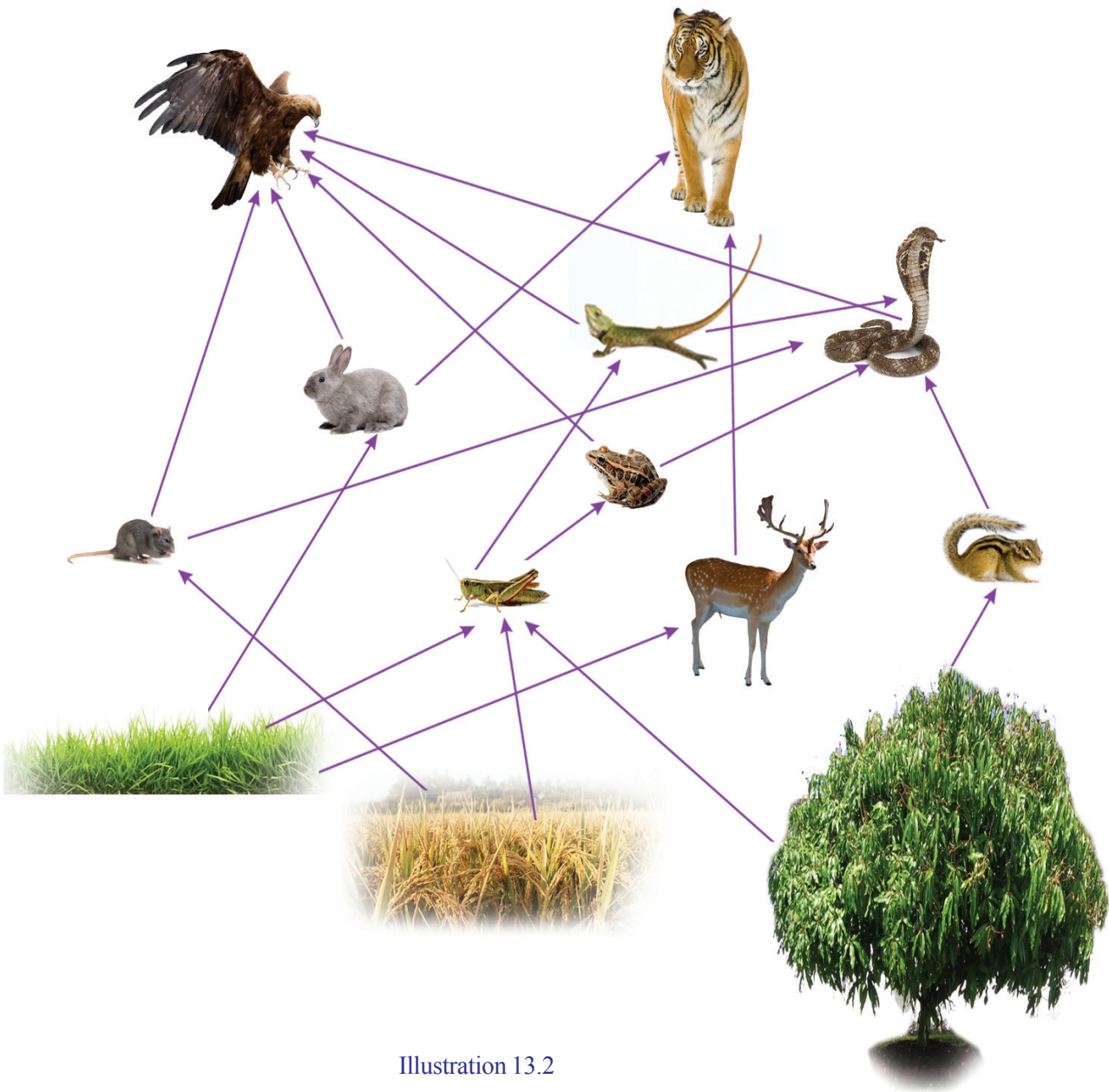

Illustration 13.2

Indicators

- How do food chain and food web differ from each other?
- Is a single organism involved in more than one food chain?
- Is the possibility of an organism becoming food to more than one organism helpful to the existence of the food chain? Why?
- How does the variation in the number of a particular organism in the food chain affect the existence of other organisms?

Trophic level

The term indicates the position of an organism in the food chain. Since the food chain starts with plants, they represent the first trophic level. Herbivores that derive food directly from plants are included in the second trophic level. Carnivores that depend on herbivores for food are included in the third trophic level. Predators that prey on carnivores represent the fourth trophic level. As the food web turns increasingly complex, the same organism may represent different trophic levels.



Did you read the note on trophic level?

Complete the illustration by including the organisms of the food web at various trophic levels.

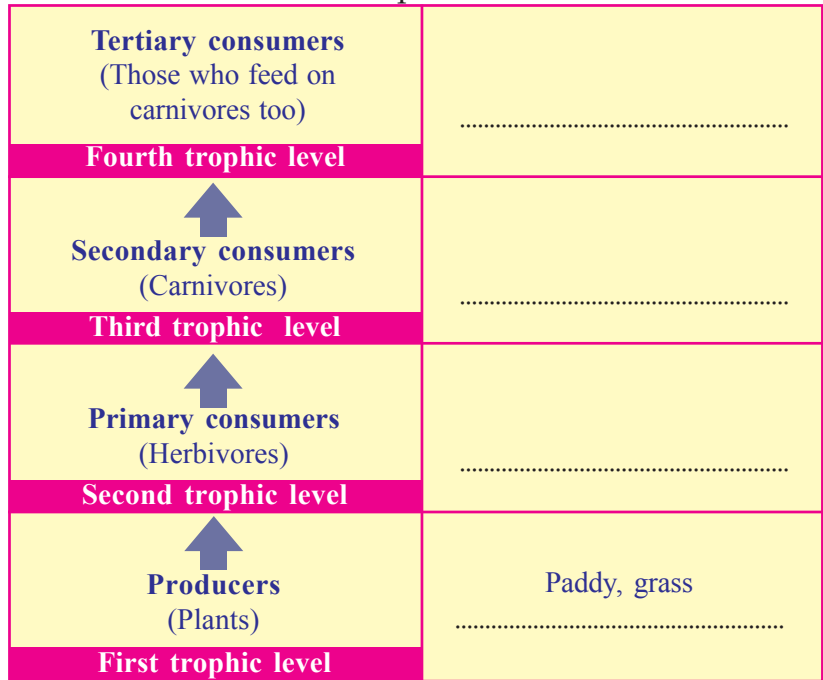

Illustration 13.3

Indicators

- Does the same organism occupy more than one trophic level?
- Is there any possibility of a fifth trophic level?
- How does the elimination of organisms from the higher trophic levels affect the ecosystem?

Examine the food chains taken from the illustration 13.2.

1. Grass → Rabbit → Eagle
2. Grass → Grasshopper → Calotes → Eagle
3. Grass → Grasshopper → Frog → Snake → Eagle

Find out the trophic levels represented by the eagle in these food chains. Write them down in the science diary. The number of trophic levels and the position of organisms in the trophic levels of the ecosystem is not constant. It changes in accordance with the complexity and the length of the food chain.

Ecological interactions

Observe the illustration of some ecological interactions.



See 'Jeevibandhangal' in School Resources in IT @ school, Edubuntu.



Illustration 13.4

Complete the illustration given below with suitable examples for ecological interactions.

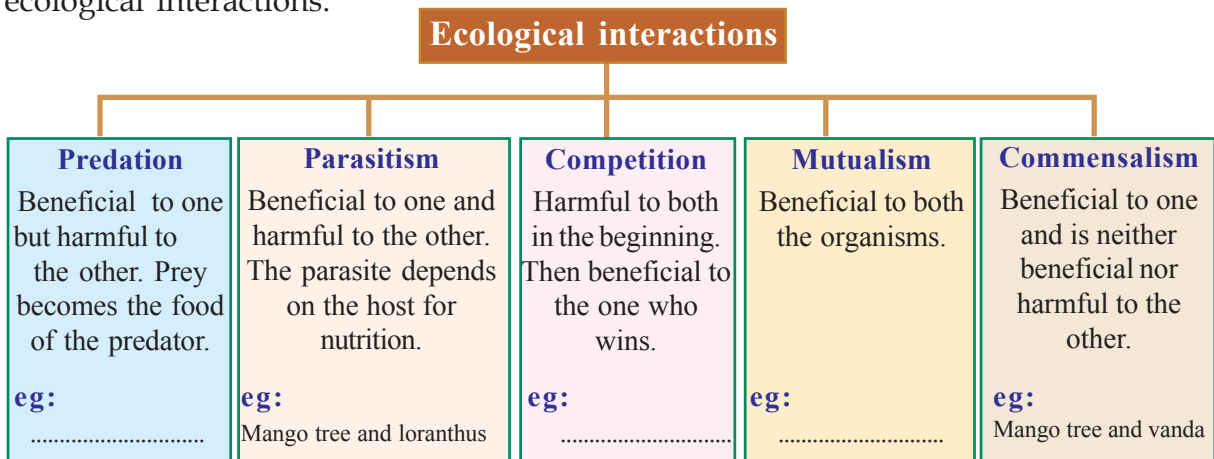

Illustration 13.5

There are many interactions in nature that we do not see or realise. These interactions maintain the balance and stability of the ecosystems. Food relations are visible instances of interaction among organisms.

The ecosystem becomes more stable as the diversity of ecological interactions and abiotic factors increases.

Diverse ecosystems

Observe the pictures given below.



Fig. 13.1 Different types of ecosystems

Collect information on the peculiarities of these ecosystems and the organisms found there. With the help of the indicators, discuss and write them down in the science diary.

Biodiversity

Biodiversity includes all the diverse organisms that inhabit the earth along with their ecosystems. Biodiversity includes various levels like ecosystem diversity, species diversity and genetic diversity. This term which denotes the richness of the biosphere was first used by a British environmentalist, **Walter. G. Rosen** in 1985.

Indicators

- Are all ecosystems alike in biodiversity?

- Are all organisms seen in an ecosystem also seen in another ecosystem?
- What is the need for protecting natural ecosystems?

Importance of biodiversity

What are the benefits of conserving biodiversity? In order to understand it, we must identify the services provided by biodiversity. Observe the illustration given below. On the basis of the illustration, prepare a note on the need for conserving biodiversity.



See Jaivavaividhyam innale, innu, nale in School Resources in IT @ School, Edubuntu.

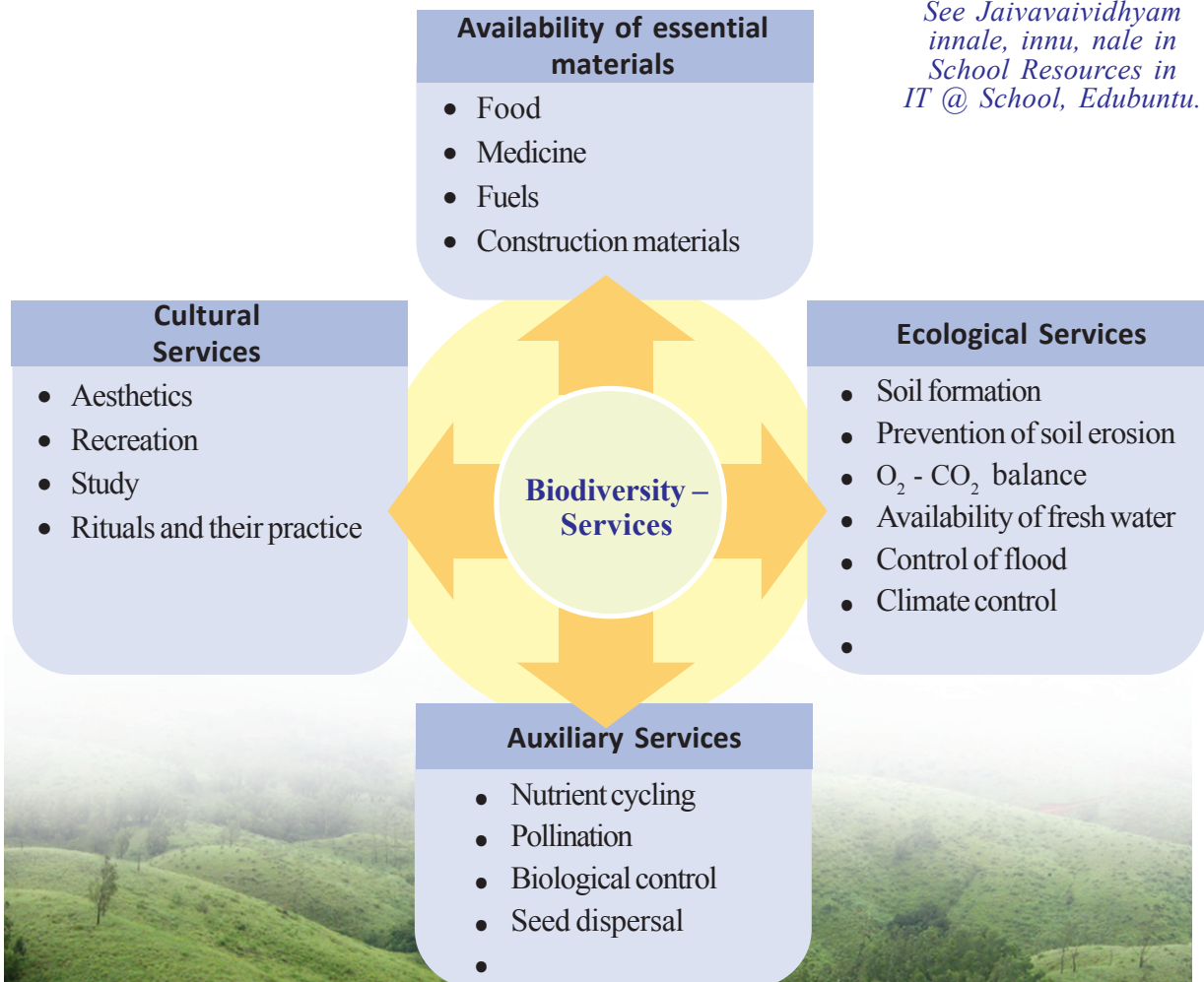

Illustration 13.6



Biodiversity depletion

What is happening to the biodiversity around us? Keen observation is necessary to understand it.

Birds are found everywhere. Birds fall easy victims to changes in the ecosystem.

Let us observe the birds around us to understand the present status of biodiversity.

Bird watching is also an interestingly scientific hobby. You can refer to books or internet to identify unfamiliar birds. Remember to note down the peculiarities of external features and the nature of the birds observed.

Observe the figure.



Fig. 13.2 Different types of birds in Kerala.

Our surroundings were once rich with a multitude of birds like these.

Has there been any change in the diversity of birds in your locality?

What is your finding?

Discuss with the help of indicators provided.

Indicators

- Large scale destruction of ecosystems.
- Over exploitation of the natural resources.

Biodiversity in Western Ghats under threat

The Western Ghats, rich in biodiversity and lying parallel to the Arabian Sea, is more than 1500 kilometre long and 1.25 lakhs square kilometre wide. This region which is also known by names like Sahya Mountain or Sahyadri is abundantly rich with ecosystems such as forests, grasslands, sacred groves, marshes, rivers and ponds. Very rare species of the world are found here. This region is rapidly deteriorating due to the thoughtless intervention of human beings. The process of deterioration of ecological diversity in the Western Ghats has been accelerated by agriculture, dams which obstruct the flow of rivers, mining, exploitation of forest wealth, tourism and hunting etc.



- Excessive use of chemicals in agricultural fields.
-
-

Along with the inferences formulated through discussion, collect relevant supplementary materials and prepare a scientific article. Exhibit it on the wall magazine.

Lost links

Observe the picture of certain extinct species. Dodo, a kind of flightless bird, was common in the island of Mauritius. Other species which have become extinct include passenger pigeons which flew in lakhs along the North American skies and the Quagga, a wild zebra variety from the southern part of Africa.

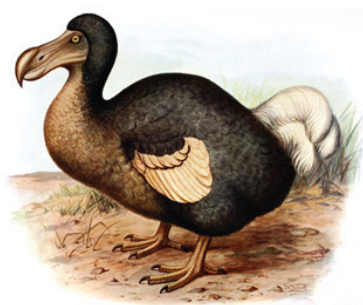

Dodo



Passenger pigeon

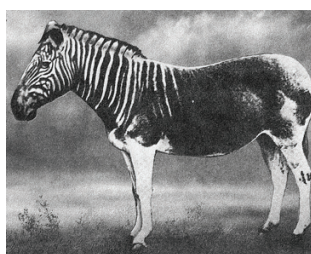

Quagga

Fig. 13.3

- What were the circumstances for the extinction of these organisms?
- Do human beings have any role in it?

Discuss and write down the inferences in the science diary.



No Bird Sings



The book *Silent Spring* published in 1962 by an American researcher, **Rachel Carson** attracted attention worldwide because it elaborated on the environmental and health hazards caused by pesticides like DDT. Carson pointed out that birds and other organisms died in large numbers when DDT mixed with petroleum products, affectionately called 'insect bomb', was sprayed widely on agricultural fields. She established with the help of study reports that most pesticides caused cancer. This book was responsible for the ban on DDT in America in 1972. In this age when deadly pesticides are widely used, the ideas put forward by Carson's work are very relevant.



If not protected, these too...!

There are many organisms on the verge of extinction due to several reasons. Some examples are given below.



Saraca indica (Ashoka tree) *Maramanjil* (Tree Turmeric)



Malabar civet cat

Nilgiri Tahr



Lion-tailed macaque

Malabar hornbill

Fig. 13.4

Red Data Book

IUCN (International Union for Conservation of Nature) is an organization for environmental protection, operating in different countries. Under the auspices of IUCN, a list of endangered plants and animals is prepared every year. This is known as the Red Data Book. Some countries prepare Red Data Book on their own. The information in the Red Data Book is helpful to identify the extent of biodiversity depletion and to plan out appropriate conservation activities.

Collect more information about these organisms and write them down in the science diary.

Let us preserve diversity

Sustainable development is possible only with the protection of nature. Analyse the illustration showing a wise approach to biodiversity.

Write down your inferences in the science diary.

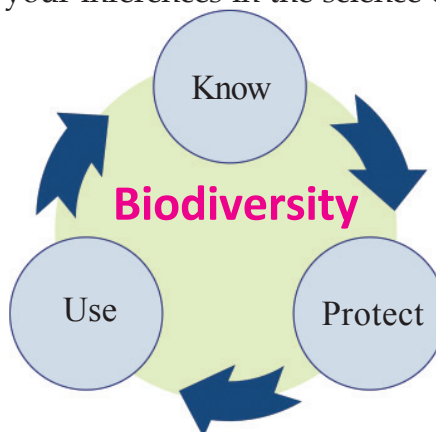

Illustration 13.7

There are many national and international organisations and legal systems working for the conservation of biodiversity. The government conserves bio-rich areas declaring them as protected areas.

Two types of conservation methods are prevalent. They are:

1. *in-situ conservation* method in which organisms are protected in their natural habitats and
2. *ex-situ conservation* method in which organisms are protected outside their natural habitats.

Let us familiarise ourselves with some examples of such conservation methods.

In-situ conservation

Wild Life Sanctuary

These are forest areas declared as protected areas to prevent the extinction of wild lives by protecting the ecosystem. Peppara, Periyar, Wayanad etc., are examples of wild life sanctuaries in Kerala.



National Parks

National Parks are designed to protect wild lives along with the protection of historical monuments, natural resources and geographical features of an area. Eravikulam, Silent Valley, Anamudi Shola, Mathikettan Shola and Pambadum Shola are the national parks in Kerala.



Community Reserves

Community reserves are areas protected with the participation of the public. These are ecologically important places located in populated areas. The Kadalundi Community Reserve spread over the districts of Malappuram and Kozhikode is an example.



Biosphere reserves

These are vast regions designed with an aim to protect world's important ecosystems, biodiversity and genetic resources. Biosphere reserves like the Nilgiris and Agasthyarkoodam include areas belonging to Kerala too.

Sacred groves

These are small areas of biodiversity protected in regions inhabited by human beings. Due to changes in life style many of these which were highly bio-rich have been destroyed. Only a few are remaining now. Sacred groves play an important role in the conservation of water in the region too.



Ecological hotspots

Ecological hotspots are areas rich in endemic species but facing the threat of habitat destruction. Each hotspot is ecologically a very important area of biodiversity. Out of the 34 hotspots all over the world, 3 of them are in India. They are the Western Ghats, North-Eastern Himalayas and the Indo-Burma region.

Complete the illustration of in-situ conservation suitably.

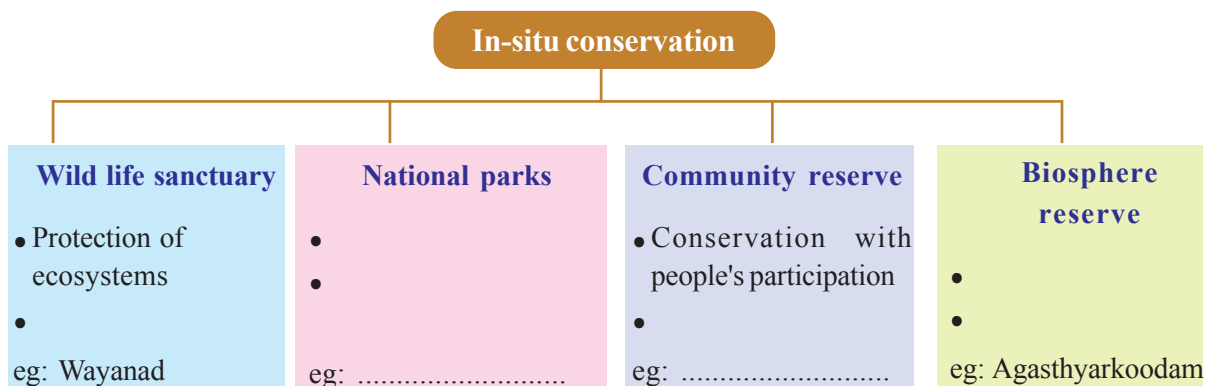

Illustration 13.8

Ex-situ conservation



Zoological gardens

Zoological gardens are conservation centres where different varieties of animals are protected and housed separately and where necessary arrangements are made available for their reproduction. They also function as conservation centres of organisms which have become extinct in wild. There are zoological gardens at Thiruvananthapuram and Thrissur in Kerala.



Botanical gardens

These are wide research centres where rare and important plants of diverse species are protected. We can identify many plants and get more information about them by visiting a botanical garden. Jawaharlal Nehru Tropical Botanical Garden and Research Institute (JNTBGRI) at Palode in Thiruvananthapuram and Malabar Botanical Garden (MBG) at Olavanna in Kozhikode are examples.



Gene Banks

These are research centres with facilities to collect seeds and gametes to preserve them for a long time. Organisms can be recreated out of them whenever required. Rajiv Gandhi Centre for Biotechnology at Thiruvananthapuram is an example.

Indicators

- What is the scope of ex-situ conservation?
- What is the significance of gene banks?



See '*Vanyajeevisamrakshanam*'
in *School Resources in IT @ School, Edubuntu.*

Many government and non-government organisations design and coordinate environment protection activities. Let us familiarise ourselves with some of the organisations and institutions at the national and international levels.

IUCN

(International Union for Conservation of Nature)

IUCN is a Switzerland based independent organisation working for the protection of biodiversity.



WWF

(World Wide Fund for Nature)

Biodiversity conservation, prevention of exploitation and pollution of natural resources are the objectives of WWF. Its headquarters is also in Switzerland.



There are organisations and institutions that work for the protection of nature in our place too. Enquire about them and collect information.

What can I do for the protection of nature?



- Plant saplings and nurture them.
- As far as possible, try to get information about forests and environment directly. Share the knowledge gathered.
- Keep the surroundings clean.
- Take part in awareness programmes.
-
-



Knowing our forests

Nature camps are conducted in about 30 centres by the Department of Forest and Wild life in Kerala. One gets an otherwise impossible opportunity to be part of safari trips into forests in these camps of one to three days duration. You can also participate in these camps by applying to the concerned wild life warden under the auspices of the school Nature Club. Make use of such opportunities to learn about forests closely.

It is our duty to conserve and keep bioresources for future generations. If we do not act with this realization, our existence itself will be in danger.



Significant learning outcomes

The learner can

- illustrate trophic levels by including organisms in the ecosystem.
- explain how the various ecological interactions influence the existence of ecosystem.
- explain what biodiversity is.
- find out the causes of biodiversity depletion and suggest remedies.
- engage in conservation activities realizing the importance of conservation of biodiversity.



Let us assess

1. Phytoplankton - zooplankton - fish - seal - shark
 - a) In which trophic level is the secondary consumer of this food chain included?
 - b) Rewrite the food chain in such a way that the organism in the third trophic level figures in the second trophic level.

2. Find the odd one out from the following. Justify your answer.
 - a) Quagga, Malabar civet cat, Nilgiri Tahr, Lion-tailed macaque.
 - b) Eravikulam, Mathikettan shola, Periyar, Silent Valley
3. Examine the statements given below and rewrite if there are errors.
 - a) Extinct species are included in the Red Data Book.
 - b) WWF is an organisation working with the objective of protection of biodiversity.
 - c) Gene banks are included in in-situ conservation.



Extended activities

1. Identify the plants and animals around you and prepare a local Biodiversity Register.
2. Prepare a science journal by including information, pictures and reports of biodiversity.
3. Prepare and exhibit posters that emphasise the importance of conservation of biodiversity.



For the Continuity of Generations



Observe the pictures related to the reproduction of plants.

Is the sprouting of sapling from a seed the same as the growth of new plants from leaves? Why?

Discuss and write down your inferences in the science diary.

There are different modes of reproduction in nature to produce new generation. Some examples are given below. Collect more information about different types of reproduction and write them down in your science diary.

Bacteria

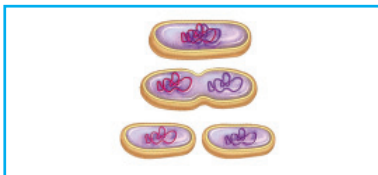

Binary fission

An existing cell divides to form two new cells. Under favourable conditions, rapid multiplication of organisms like bacteria take place by binary fission.

Fungus



Spore formation

Spores are minute cells that can survive in unfavourable conditions and develop into new organisms under favourable conditions. This is a type of asexual reproduction.

Hydra



Budding

Buds are formed in the parent body. When it grows, it separates itself from the parent body and develops into a new organism.

Fig. 14.1



Pollination and floral diversity

Pollination is an example for mutualism between plants and animals. More than two lakhs of animals help in pollination. Majority of them are insects. Fragrance and colours of flowers are means to attract insects. Now you can guess why flowers blooming at night are mostly white in colour and possess intense smell. Besides living things certain plants depend on wind and water for pollination. The shapes and nature of flowers differ according to the pollinator. Most plants have more than one pollinator. But certain plants depend on particular organisms for pollination. The extinction of these organisms adversely affects the very existence of such plants as well.



Flowers are the sex organs in plants.

Collect flowers from the surroundings and observe them with the help of a hand lens. Identify the parts that take part in reproduction and complete the illustration given below.

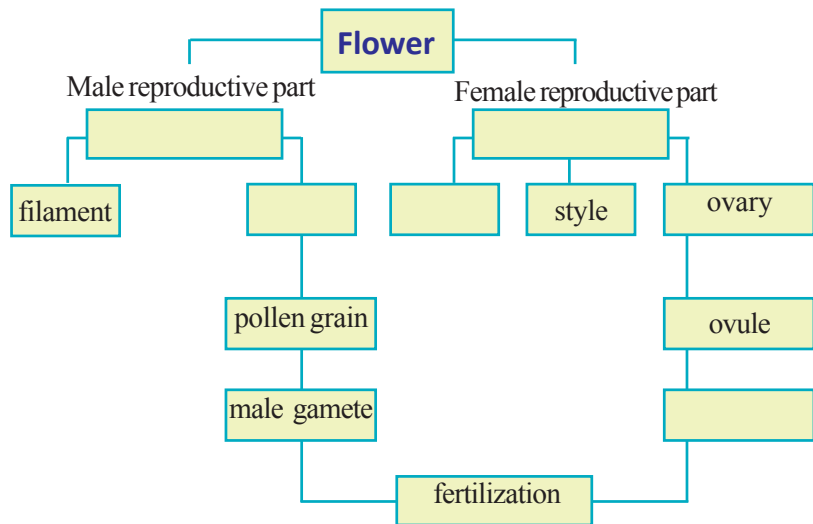

Illustration 14.1

After pollination

Pollination is the transfer of pollen grains to the stigma of the flowers. What is the change that happens to the pollen grain after fertilization?

Observe the figure.

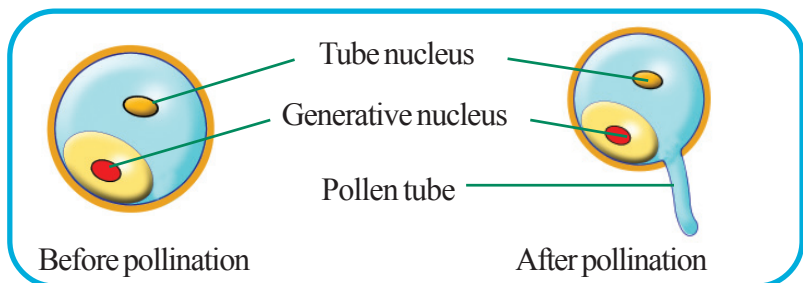

Fig. 14.2

Let us observe through a simple experiment the growth of the pollen tube from the pollen after pollination.

Plan the experiment according to the hints given in the illustration. Prepare a note on the experiment and record it in the science diary.

Stages of the experiment



Stage 1

Collect anthers from any of the flowers available in the locality. eg: lily, Mexican lilac (*sheemakonna*), hibiscus.

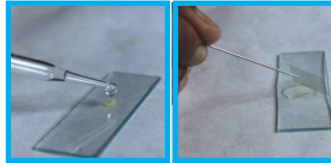
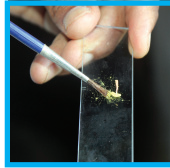

Stage 2

Place the pollen grains on a glass slide. Add 2 or 3 drops of sugar solution to it. Then place a cover glass over it.



Stage 3

Observe through a microscope after 3 to 4 hours.

Illustration 14.2

Did you observe the growth of the pollen tube? On the basis of the indicators, discuss the given notes and figure on fertilization in plants. Note down the inferences in your science diary.

Fertilization

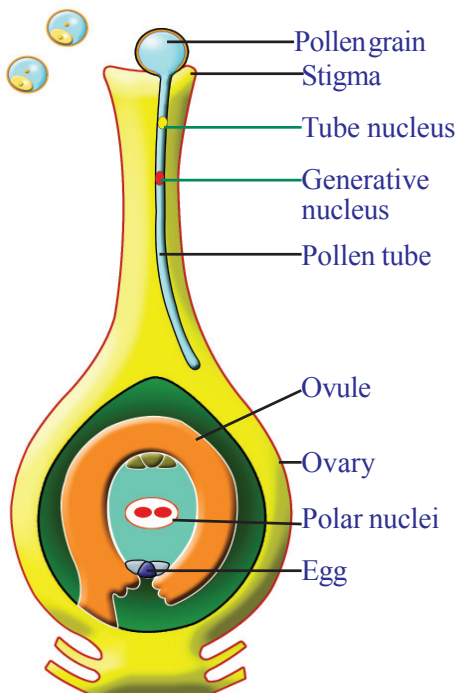

Fig. 14.3

Pollen grain contains two nuclei such as generative nucleus and tube nucleus. The pollen tube develops from the pollen grain that falls on the stigma and grows towards the ovary. Along with this the nuclei in the pollen also enter the pollen tube. The generative nucleus divides in the pollen tube to form two male gametes and the tube nucleus disintegrates.

One of the male gametes that reaches the ovary through the pollen tube fuses with the egg to form zygote. The second male gamete fuses with the polar nuclei in the ovary, and endosperm is formed from it. Zygote develops into embryo and endosperm becomes the stored food needed for the embryo's growth.

Indicators

- Formation of male gametes.
- Formation of embryo.
- Formation of endosperm and its function.

Reproduction in human beings

In higher organisms including human beings specific organ system is developed to produce gametes. Analyse the illustration and notes given below and write the inferences in your science diary.

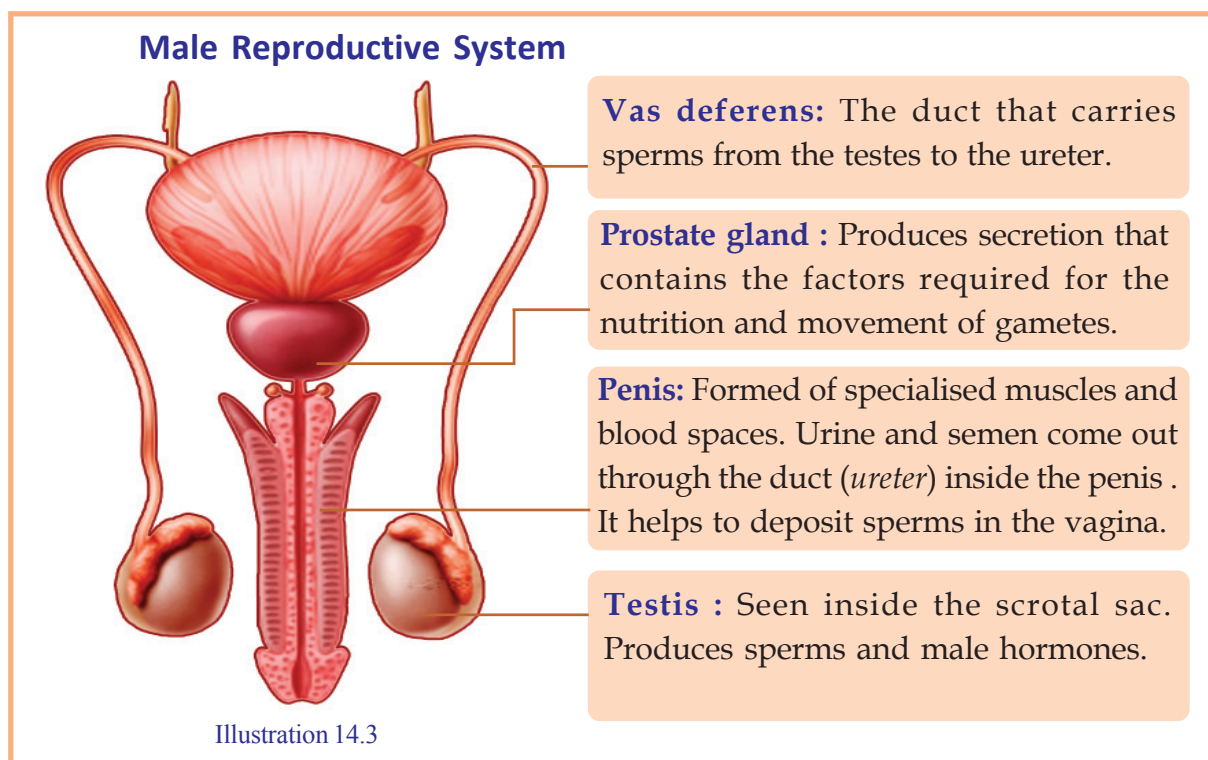

Sperm

Sperm is the male gamete. It is motile and microscopic. The sperm has a head, middle piece and a tail. They move with the help of the tail. Mitochondria, present in the middle piece, provides the energy for movement. Nucleus that contains paternal chromosomes is seen in the head.

Sperms are formed inside a pair of testes located in the scrotal sac outside the

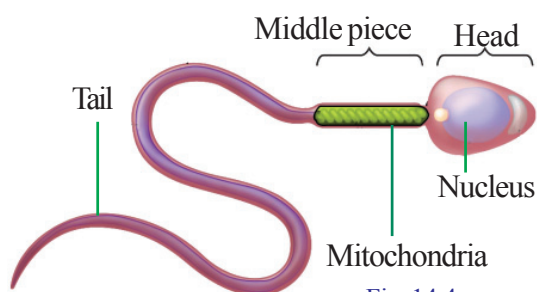

abdominal cavity. Testis also produces testosterone, the male sex hormone. Temperature less than the body temperature (35-36°C) is favourable for the formation of sperms. The scrotal sac helps to maintain this temperature. Sperms along with the secretion of glands including the prostate gland reaches the penis and is secreted outside. This process is called insemination.

Indicators

- Characteristics of sperms.
- Location of testes and the production of sperms.
- Importance of glands.

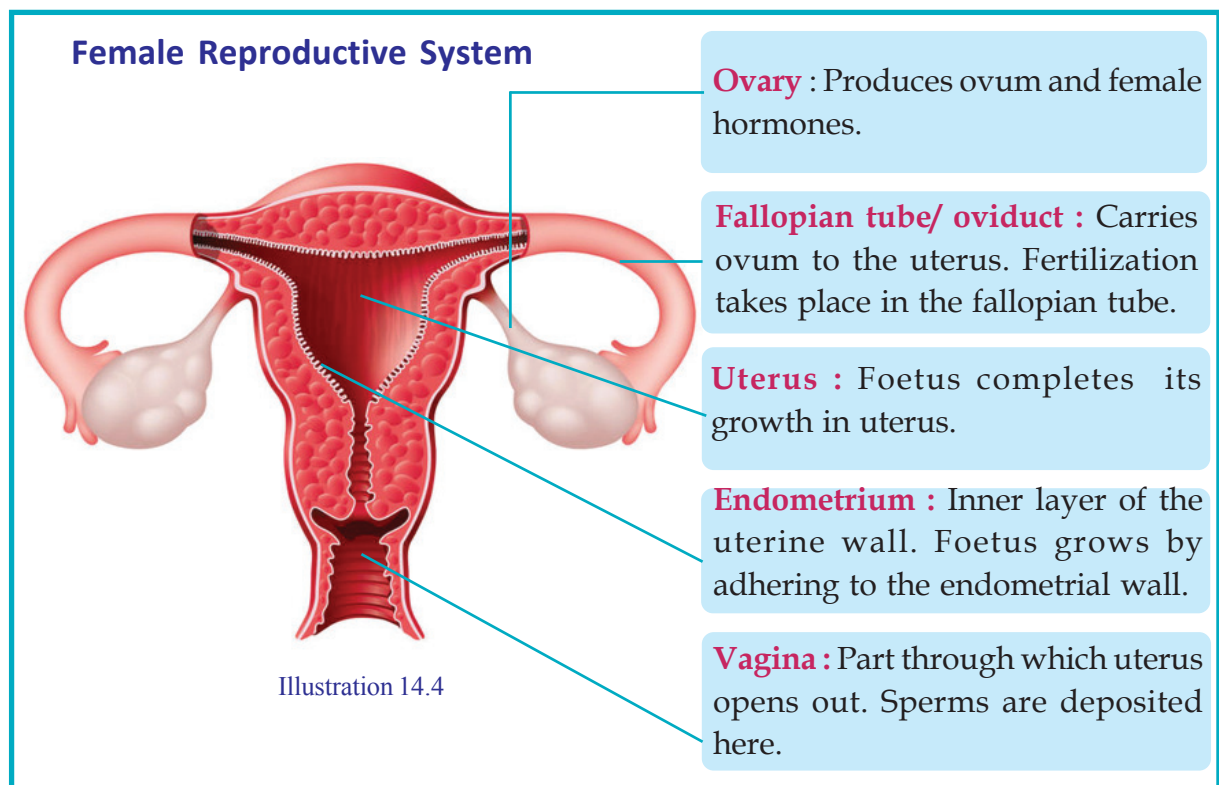

Ovum

Ovum is the female gamete. It is larger than a sperm. Ovum is non motile. Specialised protective layers are seen outside the cell membrane of the ovum.

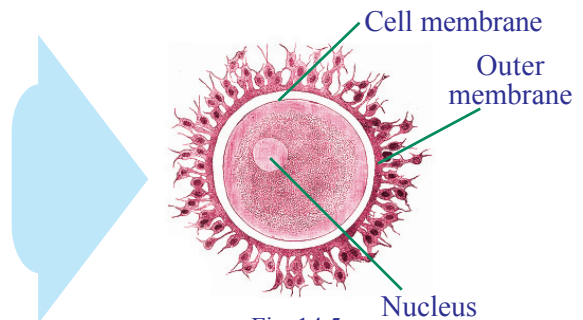
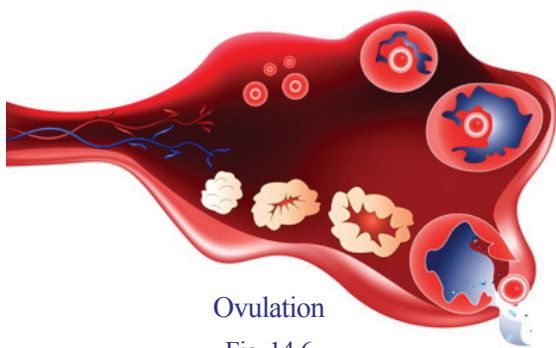

Fig. 14.5



Ovulation
Fig. 14.6

A pair of ovaries situated in the abdominal cavity produces ova, and the female sex hormones called estrogen and progesterone. Ovulation is the process of releasing mature ovum from the ovary. Normally one ovum matures per month.

Indicators

- Characteristics of ovum.
- Function of ovary.

Menstruation: a natural process

Menstruation is a natural biological process that takes place in girls as part of their physical growth. Menstruation starts early or late, in accordance with one's heredity, food habits, state of health or hormone variations. Prior to menstruation, mild back pain, pain in lower abdomen, nausea etc., may be experienced. The duration of menstrual cycle may not be the same in every individual. Generally menstrual cycle repeats once in 28 days. For the first one or two years, menstrual cycle may be irregular. If the irregularity continues, medical assistance should be sought. It is also very important to maintain menstrual hygiene. Menstrual cycle stops around 45 – 50 years of age.

You must have now understood the structure and function of gametes in human beings.

Compare the characteristics of sperms and ova and complete the given table suitably.

Characteristics	Sperm	Ovum
Size		
Motility		
Morphology		

Table 14.1

If fertilization fails to occur

Along with ovulation, the preparations for the growth of foetus take place in the uterus every month. Endometrium, the inner layer of uterus thickens and more blood capillaries and glands begin to develop. But when fertilization does not take place, all these preparations become futile. The newly formed tissues get destroyed and they peel off from the uterine wall. These tissues get eliminated through the vagina along with blood and mucus. This process is called menstruation. It may last for 3 – 7 days.

If fertilization occurs

The ovum released from the ovary reaches the oviduct. There it fuses with the sperm and forms the zygote. This process is called fertilization. Though many sperms reach the oviduct only one sperm fuses with the ovum. The single celled zygote undergoes division to become a multicellular embryo. Embryo develops by attaching itself to the endometrium, the inner layer of uterus.

Hormones

Hormones are chemical substances produced in the endocrine glands of the body. Hormones control and co-ordinate various life processes. Therefore any variation in the secretion of hormones affects the life processes considerably.

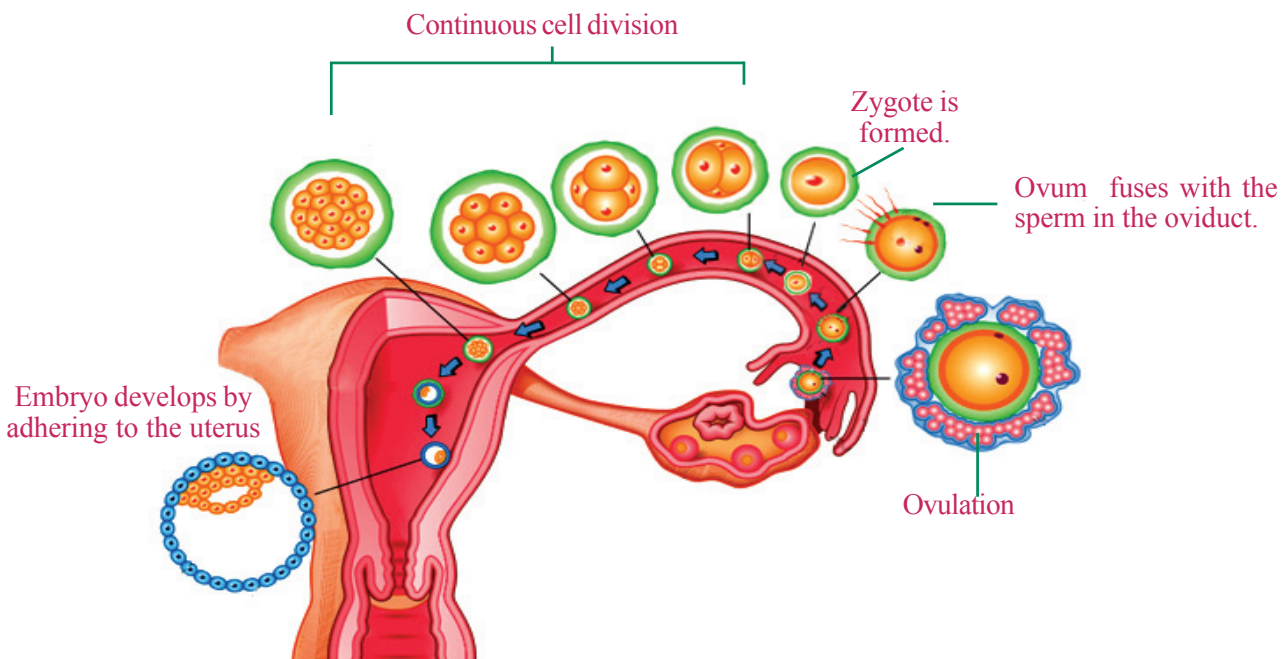

Illustration 14.5

Illustrate through a flow chart the various stages from ovulation to the beginning of embryonic development in the uterus.

Placenta

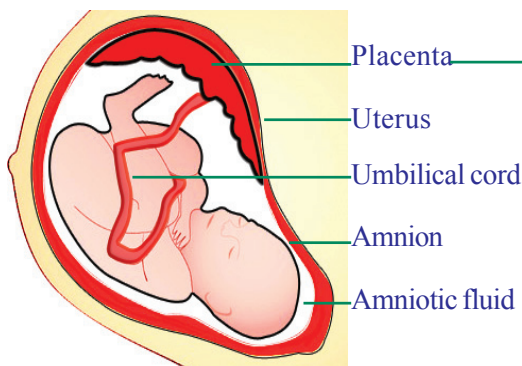

Illustration 14.6

Placenta is the part by which the embryo attaches itself to the endometrium and develops. Placenta is composed of foetal tissues and uterine tissues. Oxygen and nutrients reach the foetus through the umbilical cord developed from placenta. Waste materials are also eliminated through the placenta. Placenta helps in the exchange of materials between the mother and the foetus without mixing their blood. The growth of the foetus completes within the amnion, the membraneous covering formed from the embryonic cells during the initial stages of growth. The amniotic fluid within this covering prevents dehydration of the foetus and protects it from shocks.

Parturition

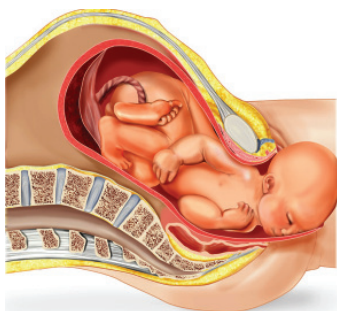

Fig. 14.7

The gestation period of human beings is about 270 – 280 days. During this period, the foetus completes its growth through gradual changes and the fully grown baby comes out through the vagina. This process is called parturition.

The growth of foetus and the birth of the baby are complex processes. Only a woman with physical and mental maturity can accept these changes and give birth to a healthy baby.

Complete the given table suitably.

Part	Function
Endometrium	
Uterus	
Placenta	
Umbilical cord	
Amnion	

Table 14.2

Observe the illustration showing the different stages of growth in human beings.

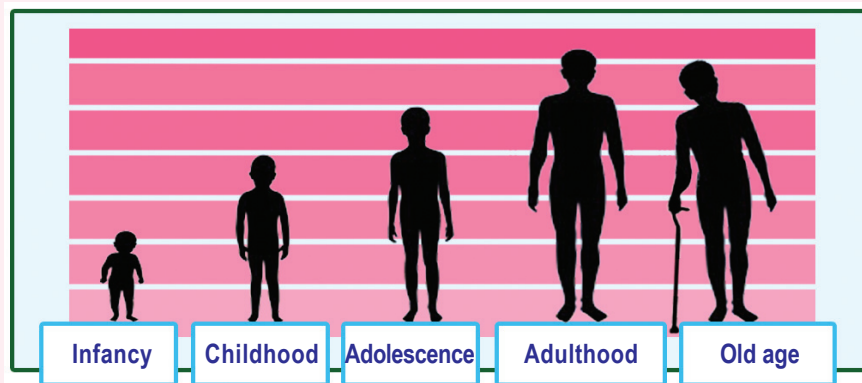

Illustration 14.7

Of these, what stage do you belong to? Read the description given below and identify the characteristics of your stage of growth.

Adolescence – a special phase in life

Adolescence is a period of biological significance. This is a period of rapid changes from childhood to adulthood. According to the statistics of World Health Organisation (WHO), the adolescence period is from 11 to 19 years. This is a period from the onset of puberty to the completion of physical growth. Puberty relates to the physical changes that occur in individuals, thereby making them capable of reproduction. In each individual, the adolescence begins with physical changes. Development of brain, rapid increase in height and weight and increased efficiency of glands are the significant features of this period.

Changes related to adolescence are more rapid in girls than in boys. This is because the parts of brain that control physical and mental changes develop rapidly in girls. Along with the rapid physical changes, intense mental and emotional changes make adolescence a significant period in one's life.

Analyse on the basis of indicators the major physical changes given below. Write down your inferences in the science diary.

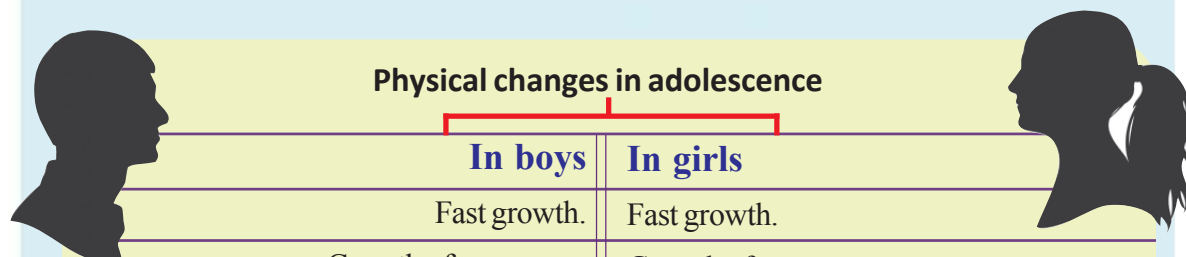

Physical changes in adolescence	
In boys	In girls
Fast growth.	Fast growth.
Growth of sex organs gains momentum.	Growth of sex organs gains momentum.
Hair grows in various parts of the body. (pubic region, armpits, face, chest)	Hair grows in the pubic region and the armpits.
Pitch of the voice deepens.	Pitch of the voice becomes sharp.
Glands in the skin become more active.	Glands in the skin become more active, breast develops.
Shoulder bones expand.	Hip bones widen.
Ejaculation starts.	Menstruation starts.

Anaemia-causes and remedies

Anaemia is a condition caused either by reduction in the number of red blood corpuscles in blood or by the deficiency of haemoglobin, the pigment in red blood corpuscles. When anaemic, blood loses its capacity to carry oxygen, and the person feels weak and exhausted. It also causes loss of memory and concentration as anaemia affects brain's efficiency.

Deficiency of iron in the body is one of the causes of anaemia. It can be remedied by including iron rich food items in the diet. Though iron tablets may be used as an immediate solution, it is advisable to ensure the availability of nutrients through regularisation of food habits.



Indicators

- What is adolescence?
- How does adolescence influence the physical and mental development of an individual?
- Why is the rate of adolescence growth higher in girls than in boys?
- Is there any need to be anxious about the physical changes during adolescence? Why?

Adolescence and food

Proper nutrition is necessary for rapid growth. Do you follow food habits that ensure the availability of nutrients? Read the newspaper report given below.

New Delhi: In India 56% of adolescent girls and 30% of adolescent boys suffer from chronic anaemia due to the deficiency of iron. To prevent this the Ministry of Health has launched a project to supply iron tablets to 13 crores of students coming under the age group of 10 - 19 years.

Source: <http://unicef.in/Whatwedo/33/Adolescents-Nutrition>

- What is the circumstance that led to the supply of iron-folic acid tablets to students?
- What is the role of food habits to overcome this situation?
- How should the food habits be regularised so as to ensure the availability of nutrients for the rapid growth of body in adolescence?

Discuss.

Food - Certain tips to follow

- Breakfast is very important. Do not skip it during busy schedule.
- Have right quantity of food at the right time.
- Choose a diet that includes fruits, vegetables and pulses.
- Reduce the intake of fried food items.

- Use sugar and salt in limited quantities.
- Do not be habituated to bottled drinks, packet food and fast foods.
- Remember that chocolate, sweets and ice creams are not good for health.
- Keep in mind that excessive likes and dislikes of food items will adversely affect health.
- Develop the habit of using seasonal leafy vegetables and fruits available in the locality.



Adolescence and the concept of beauty

The heroic images created by the media with commercial interests influence the adolescent minds very quickly. Adolescents are very conscious about their body. They mistake external appearances for personality. This makes them use synthetic cosmetics, change their food habits and follow unscientific exercises. It may cause severe health problems. The eating disorder known as anorexia, is an example. Regular skipping of food with an intention to make the body slim may cause an aversion to food which is called anorexia.

Adolescence – A period of challenges

Rapid changes in the development of the brain and in the production of hormones during adolescence cause mental and emotional disturbances. The adolescent loses the consideration and freedom of a child which he/she used to enjoy. At the same time, he/she does not get recognition as an adult either. It causes identity crisis. A lack of awareness about one's own personality during this period leads to immature decision making. As a result an adolescent may fall prey to evil influences such as imitation tendency, bad friendship and bad habits, misuse of mobile phones and internet etc. It is essential to overcome these challenges and keep away from exploitations and temptations. In short, your ability to say 'No' to whoever approaches you with wrong intentions will protect you from dangers.

Addictive habits

Smoking kills nearly 6 million people every year all over the world.

3.3 million lives are lost due to alcoholism every year.

Use of drugs causes the death of 2 lakhs every year.

Path to destruction

Tobacco contains more than seven thousand chemicals such as nicotine, benzene etc. About 70 of these chemicals are carcinogens. Smoking reduces the diameter of blood capillaries and prevents the diffusion of oxygen into the tissues. Smoking and the use of tobacco products are the main causes of cancer in the mouth, lungs, throat, oesophagus etc. Collect information regarding the health and social issues caused by smoking, alcoholism, drug addiction etc. Record them in your science diary.



Did you observe the headlines?

These are bad habits we become addicted to. Used initially out of curiosity or under the influence of friends, they subdue us psychologically and we cannot escape even if we desire to do so.

Organise an awareness programme against such bad habits, under the auspices of the School Health Club.

In front of the computer I forget everything. I am not able to concentrate on my studies.

Everybody says that recklessness is dangerous. But I like being adventurous.



Illustration 14.8

Did you notice the illustration?

Extreme rashness and misuse of mobile phones and computers are dangerous bad habits, aren't they?

Which are the other similar problems faced by adolescents?

How can we overcome such problems?

Discuss.

Need for assertiveness

If we can say an emphatic 'No' at the right time, we can avoid many dangers.



- What is your response towards this statement?
 - Can you cite such instances?
 - How will you respond if such instances occur in your life?
- Discuss.

Helping Hands



Service of a nurse

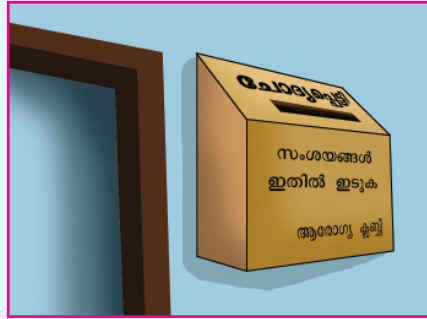

Health Club



Medical Camp



Service of a counsellor

Illustration 14.9

Are such facilities available in schools?
How can we make use of these facilities?
Discuss.



Personality development Programmes

We have around us a lot of possibilities for personality development. Participate in collective efforts in and outside the school that help us nurture our talents and also develop and promote service mentality, leadership and discipline. Develop and grow as impressive personalities.



HEALTH CLUB
Health Awareness Class
Adolescent Health Issues.

Paper Presentation: Dr. Priyamvada

Venue: School Auditorium

All are welcome

Such programmes can be conducted in your school too.

What all topics may be discussed in such a programme?

List out your suggestions.

-
-

Put your doubts in the question box and give it to the resource person who leads the class. It will make the class more effective.

Write a report of the programme in your science diary.

Adolescence – A period of possibilities



We have around us many possibilities to develop as good individuals by overcoming challenges. We can create a better tomorrow if we judiciously make use of today's possibilities.



Significant learning outcomes

The learner can

- identify and explain different stages of sexual reproduction in plants.
- identify the parts of human reproductive system and explain their functions.
- explain the reasons for the changes in adolescence and interact with one another without anxiety.
- follow good food habits by realising the importance of nutritious food.
- explain the consequence of bad habits and follow good habits.
- make use of the various possibilities to overcome health and mental issues of adolescence.



Let us assess

1. Which of the following activities takes place after fertilization in plants?
 - A. Pollen tube grows
 - B. Egg is formed in the ovary
 - C. Ovule becomes the seed
 - D. Male gametes are formed
2. Which part helps in the transportation of materials without mixing maternal and foetal blood?
 - A. Endometrium
 - B. Uterus
 - C. Placenta
 - D. Amnion
3. Sequentially arrange the process that takes place after pollination in plants.
 - Embryo is formed
 - Pollen tube grows
 - Fertilization takes place
 - Male gametes are formed
 - Zygote is formed
 - Generative nucleus divides.

4. Substantiate the statement:
“Excessive likes and dislikes of food materials adversely affects the health”.
5. Home hygiene and social hygiene are as important as personal hygiene for health. Do you agree with this opinion of the doctor who led an awareness class on health? Why?
6. “Adolescence is full of challenges and possibilities”.
 - a. What are the challenges faced by adolescents?
 - b. What are your suggestions to overcome these challenges?
7. It is easy to be addicted to drugs. But to escape from it, is not that easy.
 - a. What should be our approach towards drugs?
 - b. What are the harmful effects of drugs?



Extended activities

1. Organise an awareness programme about the existing legal aids to protect children from exploitations.
2. Biological sexual differences is a necessity for the continuity of generations. But should there be boy-girl discrimination in society? Conduct a debate on gender discrimination.



Solutions



The figure shows different types of solutions. There are many instances where solutions are made use of. Some solutions are given in the table below. Identify the states of the solute and the solvent in each of them and complete the table.

Solution - Constituents	State of the solute	State of the solvent	State of the solution
Brass (Zinc + Copper)	Solid	Solid
Salt Solution (Salt + water)	Liquid
Soda water (Carbon dioxide + water)	Gaseous
Mixture of alcohol and water	Liquid

Table 15.1

Is there any relation between the state of the solution and that of the solvent? In most of the cases, the physical states of the solvent and the solution are the same.

How do we decide the solvent and the solute in a solution?

Normally, the constituent present in smaller amount is considered as the solute and the constituent present in larger amount is considered the solvent. In aqueous solutions, water is always the solvent irrespective of its amount.

Let us examine some properties of solutions.

Concentration of solution

Take equal amounts of water in two glass tumblers. Add one or two crystals of potassium permanganate in the first tumbler and four or five crystals in the second and stir. Observe the difference in the colour of the solutions in the two tumblers.

What is the reason for the difference in the colour?

The solution containing a greater amount of solute can be said to be of higher concentration.

Concentration of a solution refers to the amount of solute dissolved in a fixed amount of solvent. A solution containing a small amount of solute is known as a dilute solution and that which contains large amount of solute is known as a concentrated solution.



Expressing Concentration

Concentration of solutions can be expressed in different ways.

Mass percentage

The amount of solute that gets dissolved in a solution can be expressed in percentage using this method. This denotes the amount of solute present in hundred grams of the solution.

Mass percentage =

$$\frac{\text{mass of solute}}{\text{mass of solution}} \times 100$$

Parts per million (ppm)

This denotes the number of parts by mass of a solute present in ten lakh (one million) parts by mass of a solution. 'ppm' is used to express the presence of very small amounts of a solute. For example, the allowed limit of chlorine in drinking water is 4 ppm.

Volume percentage, molarity, molality and normality are some other scales used to express the concentration of solutions.

Saturated Solution

Do different materials dissolve to the same extent in a given solvent?

Take 50 mL each of water in two beakers. Take 100 g each of powdered common salt (sodium chloride) and ammonium chloride. Stir and dissolve the common salt gradually in the water in one of the beakers. Continue doing this till no more salt dissolves. Such a solution, in which maximum amount of solute has been dissolved, is known as a saturated solution.

The solution obtained by dissolving maximum

amount of solute at a given temperature is known as a saturated solution.

The solution before reaching saturation is known as an **unsaturated solution**. Unsaturated solutions can dissolve more amounts of solute.

The amount of salt that is used to prepare the saturated solution can be found out from the amount of salt that is left behind.

Repeat the above activity by adding ammonium chloride gradually to the second beaker. Is it possible to prepare the saturated solution of ammonium chloride this way?

Compare the amount of ammonium chloride with that of common salt. Which is greater? Find out. It is now clear that the amounts of common salt and ammonium chloride required to make a saturated solution using the same solvent under the same condition differ.

The amount of a solute in grams required to convert 100 g of a solvent into a saturated solution at a given temperature is known as the solubility of the solute in that solvent.

Supersaturated solution

Is it possible to dissolve more amount of the solutes in the saturated solutions prepared before?

- Is there any change in the amount of solute dissolved when the temperature changes?

Add a little more of common salt to the saturated salt solution and heat it. What happens? Does it get dissolved? Repeat the experiment with the saturated solution of ammonium chloride.

Leave these solutions undisturbed and allow them to cool gradually to the room temperature.

Observe the two solutions. Does crystallisation occur?

Such a solution, which contains more amount of solute than that is required to saturate it, is known as a **supersaturated solution**.

- While preparing saturated solutions of various solutes in a definite amount of a given solvent under the same conditions, will the amount of solutes getting dissolved be the same? Try to find out.

The nature of solute and the temperature are two factors that influence solubility.

Observe the solubility of the following substances at 30°C (Table 15.2).

Salt	Solubility (g/100 g)
Sodium chloride	36.1
Potassium nitrate	48
Potassium chloride	37.2
Copper sulphate	37.8
Sodium nitrate	87.6
Calcium chloride	100
Calcium sulphate	0.264
Ammonium chloride	41.4

Table 15.2

Given is a graph that connects the solubility and the temperature of certain salts (Fig. 15.1).

Examine the graph and find out the following:

- Which substance shows maximum increase in solubility as temperature increases?
- Which salts have the same solubility at a temperature of 40°C?
- Which substance shows a decrease in solubility with increase in temperature?
- Prepare a note on the influence of temperature on the solubility of substances. Give examples.

Growing crystal

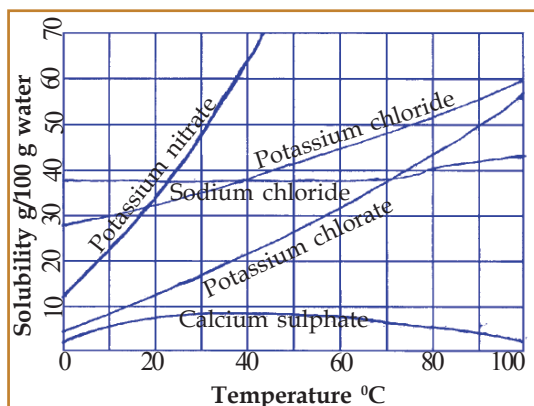

Fig. 15.1

Let's do the following activity.

What is the amount of copper sulphate needed to prepare 100 g (100 mL) of its saturated solution at 30°C? Find out from the table.

Prepare 25 mL of a saturated solution of copper sulphate. Heat this solution and prepare a supersaturated solution by adding more amounts of solute. Cool this solution gradually to normal temperature. Hang a small crystal of copper

sulphate in this solution as shown in the figure 15.2. Make sure to select a small crystal of CuSO_4 . What change do you observe after some time? Observe after a day. Has any change occurred? Record your observation. When a solute crystal is placed in a supersaturated solution, the excess of the solute crystallises as small crystals. The crystal can be seen to grow as well. What could be the reason for this? Repeat the experiment using a saturated solution of a different salt.

Classification of mixtures

All solutions are mixtures. Still, do all mixtures exhibit the same nature?

If the composition of the constituents is the same throughout the mixture, it is known as a homogeneous mixture. All solutions are homogeneous mixtures. Eg. sugar solution, salt solution, air, ornamental gold.

The components of such mixtures cannot be seen separately with the naked eye.

If the components in a mixture are not distributed uniformly, it is known as heterogeneous mixture. Eg. a mixture of salt and sand, muddy water, a mixture of water and kerosene.

Here the components can be seen separately with the naked eye.

True solution, Colloid, Suspension

Let's do an experiment.

Take equal amounts of water in three separate beakers. Add copper sulphate crystals in the first, milk in the second and chalk powder in the third beaker. Stir them well. Keep the beakers undisturbed for some time (Fig. 15.3).

In which of these beakers did the substance settle down?

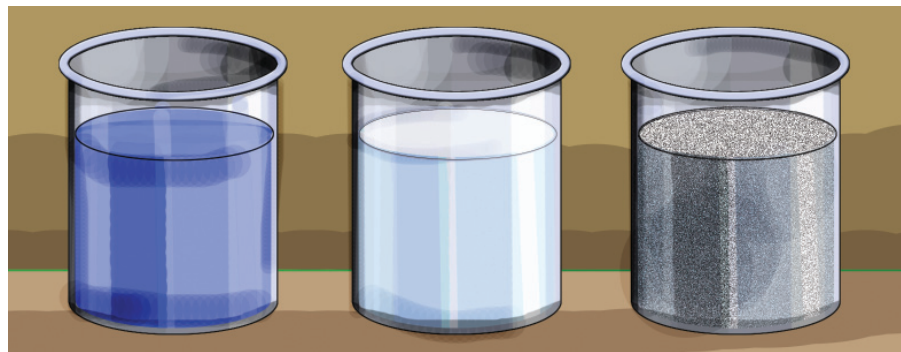

Beaker - 1
Copper sulphate + Water

Beaker - 2
Milk + water

Beaker - 3
Chalk powder + water

Fig. 15.3

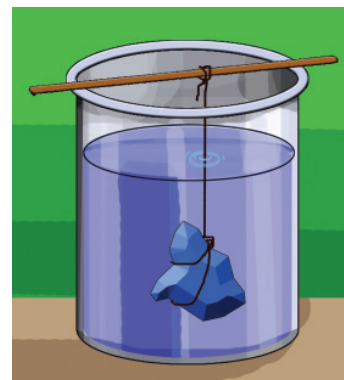

Fig. 15.2
Crystal growth

Stir it again and pass an intense beam of light through the sides of the three beakers. Tick your observations in table 15.3.

Filter the three mixtures using a filter paper.

Observation	Beaker - 1	Beaker - 2	Beaker - 3
Path of the beam can be observed			
Particles can be observed			

Table 15.3

Beaker - 1 contains a true solution. Beaker - 2 contains a colloid and Beaker - 3 contains a suspension. Tabulate the characteristics of each mixture you have observed.

Activity	Solution	Colloid	Suspension
Filtering using a filter paper	Particles cannot be separated by filtration
Passing an intense beam of light	Path of the light beam is not visible	Path of the light beam is visible
Keep it undisturbed	Particles settle down

Table 15.4

The difference observed is due to the change in size of the particles present in them.

Which mixture in these beakers has the smallest particle size?

How was this identified?

Which mixture has the biggest particle size?

The size of solute particles present in a solution is so small that it cannot be seen with the naked eye. Since these particles are very minute, they cannot scatter a beam of light. Hence, the path of the light beam is not visible.

In the case of colloids, the solute (colloidal) particle size is comparatively bigger. Hence, they scatter a beam of light, thus making the path of the beam visible.

Particles of suspensions are big enough to be seen with the naked eye. The light falling on them is reflected almost completely. They

gradually settle down under the influence of gravity.

Evaluate the following mixtures:

Ink, muddy water, fog, atmospheric air, milk, sugar solution, dilute rice water.

Classify them into true solution, colloid and suspension (Table 15.5).

True Solution	Colloid	Suspension

Table 15.5

Have you noticed that the path of the light beam can be clearly seen due to the dust particles in a cinema theatre and in smart classrooms where visuals are shown using a projector? What is the reason behind this?

Let's do an experiment.

Prepare a solution by adding 2 g sodium thiosulphate (hypo) in a beaker containing 50 mL of water. Arrange the beaker in the path of a beam of light as shown in the figure (Fig. 15.4) and add a few drops of dilute hydrochloric acid. Stir the solution. Observe for a while. Record your observations.

Sulphur gets precipitated when sodium thiosulphate reacts with dilute hydrochloric acid. Before the chemical reaction, the mixture existed as a solution. Within a few seconds, as more and more sulphur particles form, they aggregate together. The particle size thus gets bigger and forms a colloid making the path of the light beam visible. Further, more and more sulphur particles get separated and the size of particles keep on increasing. Thus the mixture becomes a suspension.

Tabulate the mixtures that we use in our daily life into solutions, colloids and suspensions. Are colloids and suspensions homogeneous mixtures? Discuss and find out with the help of your teacher.

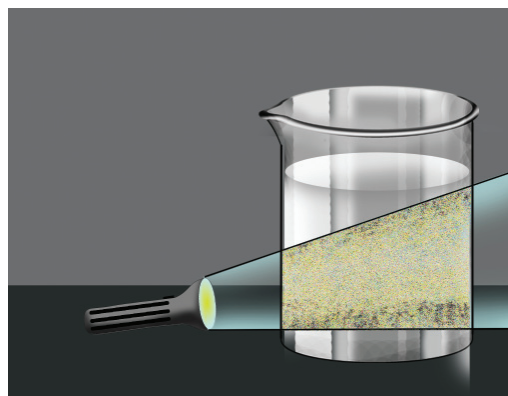

Fig. 15.4

Soft drinks

Most of the juices that we drink are liquids in the colloidal form. Such juices and liquids are available in the market. They do not settle down even after prolonged storage.

How are they retained as such for long periods of time without settling down? Do you know that some substances are added for this purpose? Such substances are called stabilisers.

Are chemicals added to soft drinks only for this purpose?

What are the other purposes for which chemical substances are added in soft drinks?



Stabilisers

Some chemical substances used as stabilisers in soft drinks to prevent the particles from getting settled are:

- Brominated vegetable oil
- Sucrose acetate isobutyrate
- Glyceryl ester of Rosin

- -----
- -----



Familiarise yourself with some chemicals which are used in soft drinks to make them attractive (Table 15.6).

Chemical Substance	Juice/food materials to which it is added	Use
Tartrazine	Food material	Colouring agent (yellow)
Erythrosine	Food material	Colouring agent (red)
Vanillin	Food material	Taste enhancer
Phosphoric acid	Soft drinks	To give sour taste
Allyl hexanoate	Food material	For fragrance (pineapple)

Table 15.6

Most of them are injurious to health. Isn't it dangerous to add such chemicals to soft drinks? How does the continuous use of soft drinks affect the human body? Why don't you conduct an investigative study along with your friends?

From where can you collect the relevant information regarding these?

- Teachers
- Doctors
- Researchers
- Reference books
- Internet
- Health workers
-

What extension activities can be planned based on these findings?

Plan after discussing with your friends and thinking logically.



Significant learning outcomes

The learner can

- identify solutions existing in solid, liquid and gaseous states.
- identify and tabulate the solvent and the solute in different solutions.
- prepare saturated and supersaturated solutions based on the concentration of solutions.
- classify mixtures into homogeneous and heterogeneous ones.
- classify mixtures that are used in daily life into solutions, colloids and suspensions.
- identify the chemicals used in soft drinks and food materials that are injurious to health and engage in awareness programmes on how such chemicals affect the health.



Let us assess

- Given below are some solutions. Identify and write down the solvent and the solute present in them. (Hint: Those present in large amount is the solvent and that in small amount is the solute).

Solution	Solvent	Solute
Salt water		
Ornamental gold		
Soda water		
Dilute hydrochloric acid		

- Haven't you noticed the caption "**Shake well before use**" in certain medicine bottles?
 - To which class do the substances in them belong to? (colloid, solution, suspension)
 - What is the relevance of such instructions on these bottles?
- Given below are some activities and observations done by a student using samples of dilute rice water, salt water, and muddy water.

Activity	Observation		
	Muddy water	Salt water	Dilute rice water
Passing a beam of light	Path of the beam of light is not visible
Filtering using a filter paper	Components can be separated by filtration
Keeping undisturbed for some time	Particles do not settle down

- Complete the table with the missing observations.
- Classify these samples into solution, colloid and suspension.

4. There are numerous instances in daily life where solutions are being used. Tabulate some of them.
5. You are now familiar with different types of solutions.
 - a) What is the difference between saturated and super saturated solutions?
 - b) How will you prepare a supersaturated solution of common salt?
 - c) Unsaturated and supersaturated solutions of copper sulphate are prepared in separate beakers and a crystal of copper sulphate is dipped into each one of them. What would be the observation after a day? Give reasons.
6. Classify and tabulate the mixtures given below into solution, colloid and suspension:
Milk, fog, atmospheric air, dilute acid, lime water, ink, smoke.



Extended activities

1. Collect empty bottles of various synthetic soft drinks and find out their ingredients from the labels. Are there common substances which are used in these drinks? Which are they? Find out their uses.
2. Prepare a solution of sugar candy in a vessel. Heat the solution and prepare a supersaturated solution by adding more sugar candies. Cool the solution and hang a small crystal of sugar candy using a string. Observe and record your observations after a week. Give reasons for your observations.
3. Take equal amount of water (50 mL) in four glass tumblers. Add equal amount of washing soda, baking soda, common salt and sugar to them. Which among these dissolve faster? Try to find out which among them require more amount of the substance for the preparation of a saturated solution?
4. Find out more examples of mixtures. Classify them into homogeneous and heterogeneous mixtures.



Water



Water is a precious natural resource.

Do you know that the substance of water is the cause for the origin of life on earth? Isn't it interesting that 65 percentage of the body parts of animals and plants contain water?

Water is essential not only for sustaining life but also for agriculture, industry, energy production and transportation. We use water for different purposes in day-to-day life. We get water in large amount from different natural resources. Rain water, wells, backwaters, streams, rivers and oceans are different water resources.

Prepare a note on the importance of water and present it in your classroom.

Water is a substance found in nature in all the three states of matter namely solid, liquid and gas.

What are the characteristics of water you are familiar with?

Boiling Point of Water

Arrange the apparatus as shown in Fig. 16.1.

Take three quarters of water in a round bottomed flask. Arrange a thermometer in such a way that it is kept immersed in water inside the flask. Record the initial thermometer reading.

Heat the water in the flask. Record the temperature from the thermometer at regular intervals of time.

When does the temperature remain constant?

What happens to the water when temperature remains constant?

This temperature is called the boiling point of water.

The temperature at which a liquid boils at normal atmospheric pressure is its boiling point. The boiling point of water is 100°C.

Once boiling starts, why does the temperature not rise accordingly even when heat is supplied?

Is there any change in temperature if the thermometer is raised a little and kept just above the surface of water when water boils?

Once water starts boiling, the temperature will not change because all the heat supplied is utilised for the change of state. Hence, all the excess heat supplied will be contained in the steam at the same temperature.

Now, can you explain why steam causes more severe burns than boiling water at the same temperature?

Does water containing other dissolved substances also boil at 100°C? Find out by heating water after adding some common salt to it.

It is easy to prepare food in pressure cookers. Do you know why? The boiling point of water increases with an increase in the pressure. In pressure cookers, water boils at 120°C. Hence, high temperature exists inside the cooker. What about decrease in pressure? In high altitude regions water boils at a temperature below 100°C. What do you understand from this?

Does water vapourise only at its boiling point?

Water exists in the liquid form at temperatures between 0°C and 100°C. But water changes to vapour at any temperature upto 100°C. Evaporation is the process by which a liquid changes to vapour. On heating water, the heat absorbed is utilised for rise in temperature and for evaporation.

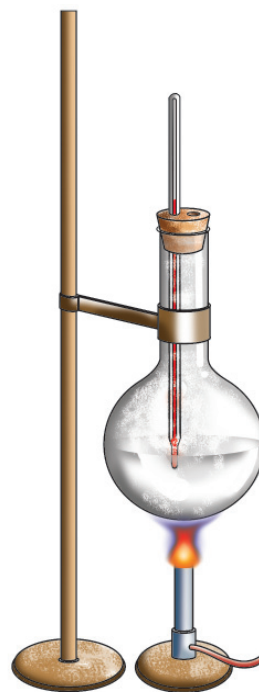

Fig 16.1

Heat capacity of water

Take equal quantity of water and coconut oil in two separate beakers and heat them in a water bath. Measure the temperatures of water and coconut oil at regular intervals using a thermometer.

Which of the two temperatures reaches a higher value in a specified time? Find out.

Even when the same amount of heat is supplied to equal quantities of water and coconut oil, why doesn't the temperature of water increase suddenly?

Water has the ability to hold more heat (heat capacity) when compared to other substances.

The following are some of the situations which make use of the high heat capacity of water.

- Water is used in radiators to regulate the heat in automobile engines.
- Water is used to cool hot objects.
- Two thirds of the earth is water. This regulates the temperature of the earth.

More than 65 percent of the body of plants and animals is water. What is its advantage? Think.

Freezing of water

We are familiar with water getting frozen in freezers. Water changes to ice when its temperature reaches 0°C.

Freezing point of a liquid is the temperature at which it freezes to solid at normal atmospheric pressure. The freezing point of water is 0°C.

Normally, all substances shrink on cooling and their volume decreases. This increases its density.

If that is the case, ice should sink in water. But, does it happen? Find out.

What did you observe? What would be the reason?

Which is denser, ice or water?

Take three quarters of water in a glass bottle, note the water level, close it and place it in the freezer. After a

Anomalous expansion of water

When water is cooled, its density increases and the cold water goes down. This occurs till the temperature reaches 4°C. When atmospheric temperature goes below 4°C, due to anomalous expansion of water its volume increases while its density decreases. Water below 4°C rises to the surface. It freezes and covers the surface of water with ice which is less dense than water. Aquatic life in water bodies at colder regions is sustained in the water below this layer of ice.

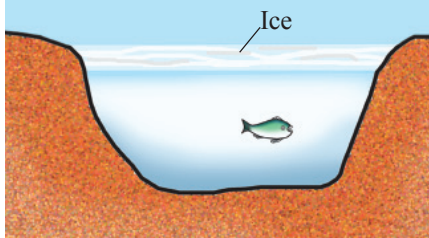

See 'Manjupalikalkidayile kulam' in IT @ School, Edubuntu.

few hours take the bottle out and observe it. When water freezes to ice, does it expand or shrink?

When water is converted to ice its volume increases and the density decreases.

Surface tension of water

Have you seen certain insects moving on the surface of water? Have you ever thought how this is possible?

Fill a trough with water and place a blade carefully on its surface (Fig. 16.2).



Fig 16.2

It can be seen that the blade does not sink. What could be the reason?

You know that molecules of a liquid attract each other.

Look at Fig. 16.3 that illustrates how molecules of water attract each other.

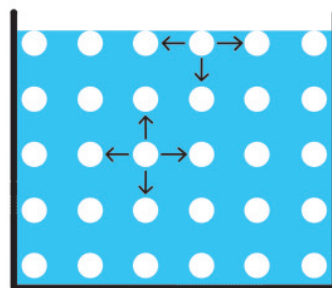

Fig 16.3

The number of molecules in vapour form just above the surface of water is less than those on the surface. Hence the attraction towards the sides and the interior will be greater. Consequently, the liquid surface behaves like a stretched membrane. This behaviour causes surface tension.

Small insects can move randomly on the surface of water. A blade can float on water. All these are due to surface tension. Surface tension is a characteristic property of all liquids.

Tie a thread to a metallic loop, immerse it in soap water and create a soap film in it as shown in Fig. 16.4 (a).

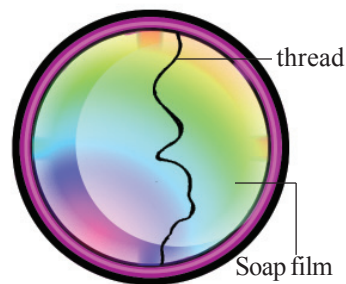

Fig 16.4 (a)

Prick a portion of the film using a pin. What is the shape of the remaining portion of the film?

Compare your findings with the figures given below:

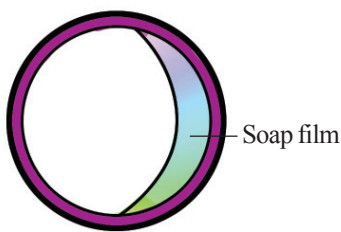

Fig 16.4 (b)

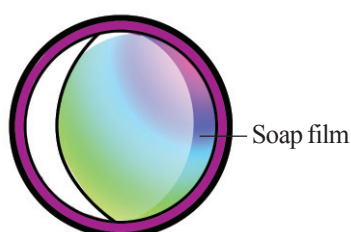

Fig 16.4 (c)



Laundry and Soap

How does the remaining soap film appear? Tick (✓) the correct one.

The surface area of soap film decreases (Fig. (b))

The surface area of soap film decreases (Fig. (c))

Small water drops can be seen in spherical forms. Why do water drops assume spherical shape?

Surface tension acts in such a way so as to reduce the surface area of a liquid. For the definite mass of a substance, surface area is minimum for spherical shape. That is why liquid droplets assume spherical shape.

Can we reduce the surface tension of water? Add some soap solution carefully through the sides to the water in the tray in which the blade floats.

What happens to the blade?

It can be understood that soap decreases the surface tension of water.

Components of water

You have studied that water is formed by the combination of the constituent elements, hydrogen and oxygen.

Hydrogen and oxygen can be produced by decomposing water and water can be produced by combining hydrogen and oxygen.

Water can be decomposed into its components by electrolysis. For this we can make a water voltameter as shown in Fig. 16.5. Iron nails and plastic bottles can be used for this. Two test tubes filled with water are kept inverted over the iron nails without allowing any air bubbles to enter.

Add a few drops of an acid to the water and then pass electricity through it from a battery. Collect the gases liberated in the test tubes. Mark the water levels in the test tubes after the experiment. Can you observe anything special? Introduce a burning incense stick into the gas collected in the test tube that is connected to the negative terminal of the battery.

In order to remove dirt from the fabric, water should move easily through the fine threads of the fabric. It is only possible by decreasing the attractive forces between water molecules. This can be done by decreasing the surface tension of water. Soap can decrease the surface tension of water. Hence, washing clothes is easier with soap. Soap molecules can get into the particles of dirt in the fabric, attract water molecules and reduce the surface tension of water. Thus, dirt particles are easily removed from the fabric along with water molecules.

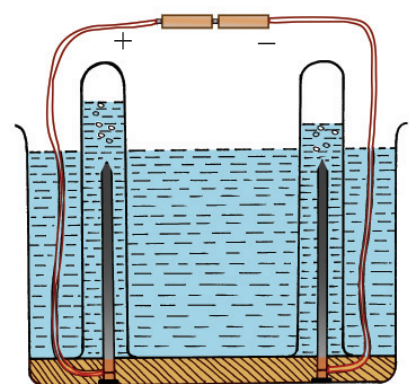

Fig 16.5
Electrolysis of water

What is your observation?

This combustible gas is hydrogen.

What will happen if a glowing incense stick is inserted into the gas collected in the test tube connected to the positive terminal?

The gas which helps the incense stick to burn with a blaze is oxygen.

Electrolysis of water can be conducted conveniently using Hoffmann Water Voltmeter (Fig.16.6). The volumes of hydrogen and oxygen obtained in these experiments will be in the ratio 2:1. Water molecule contains hydrogen and oxygen atoms in the same ratio and hence it is represented as H_2O .

Prepare hydrogen by treating zinc with dilute hydrochloric acid in a test tube.

Collect the hydrogen thus produced in another dry test tube. (You know that hydrogen is less dense than air. Hydrogen is to be collected by keeping an inverted test tube above the test tube in which the reaction occurs.)

Insert a burning incense stick into this test tube. What happens? Here the gas reacting with hydrogen is the oxygen present in air.

Observe the sides of the test tube. What do you observe?

Presence of water droplets on the sides of the test tube shows that oxygen reacts with hydrogen to produce water.

Reaction of water with metals

You know that iron corrodes (rusts) in the presence of water.

You might have studied that metals like sodium, potassium and calcium react with cold water to release hydrogen.

Put a piece of well cleaned magnesium into water in a test tube.

Do you observe any gas being formed?

Try using hot water for the experiment.

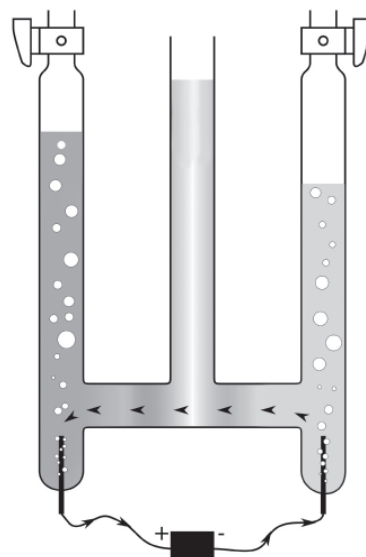

Hoffmann
Water Voltmeter
Fig 16.6

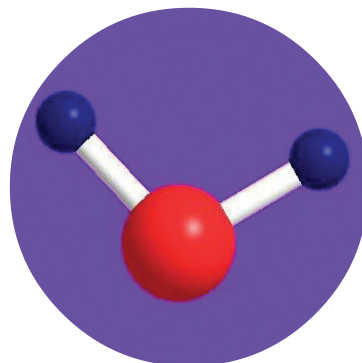

The ball and stick model
of a water molecule



See 'Vaidyutha
Vishleshanam' in
IT @ School, Edubuntu.

Using ghchemical in
IT @ School, Edubuntu you
may construct the ball and
stick model of a water
molecule.

Do you see any difference?

The incomplete chemical equation for this reaction is given below. Complete it.



You would have identified the gas formed here.

Magnesium reacts with hot water and iron reacts with steam to liberate hydrogen gas. Metals like copper, silver, gold, platinum etc., have no chemical reaction with water.

Water – the universal solvent

Dissolve the following substances in water taken in different glass tumblers.

1. Table salt
2. Sugar
3. Vinegar

Stir each solution well using separate spoons. Take small amounts of each solution and taste it. What difference do you observe?

When substances dissolve in water they acquire the property of the substance dissolved.

Applying the knowledge acquired from previous classes, let's conduct an experiment.

Take distilled water or rain water in three test tubes. Add two drops of hydrochloric acid solution to one test tube and two drops of sodium hydroxide solution to another one. Dip small pieces of pH paper, blue litmus paper and red litmus paper in all the three and observe. What happens to the nature of water? Record the observations.

- Ordinary water :
Water mixed with acid :
Water mixed with alkali :

Pure water has neither the properties of acid nor those of alkali. Hence it is called *neutral solvent*.

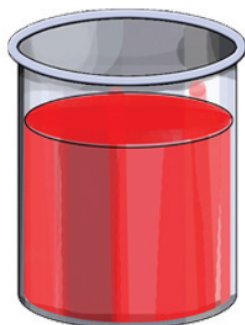

Water containing red ink

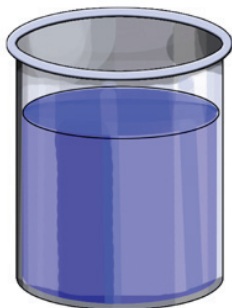

Copper sulphate solution

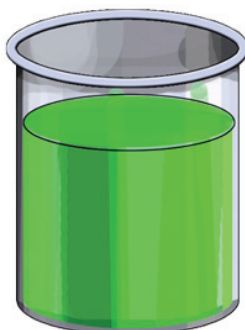

Nickel sulphate solution

Fig 16.7

Perform another experiment.

Add coloured inks, coloured salts (copper sulphate, nickel

sulphate etc.) to water taken in different beakers and mix them well (Fig 16.7). Observe the colour change in water. Water can acquire the colour of any coloured substance added to it.

Identify situations in which the above characteristic of water is made use of.

Since water can dissolve various substances and is widely used for preparing solutions, it is a *universal solvent*.

Soft water and hard water

Rain water gets filtered and flows through the soil to reach well, rivers and sea. During this process, many substances present in the soil get dissolved in it. It has been found that mostly the salts of calcium and magnesium get dissolved in water.

Take three test tubes containing water in which the bicarbonate, chloride, sulphate of calcium or magnesium is dissolved. Take pure water (rain water or distilled water) in another test tube. Put small soap pieces of equal size in all the test tubes. Shake the test tubes well. In which of these test tubes do you see more lather? Why does soap not lather easily in other solutions?

The water in which soap does not lather easily is called hard water. Here, the hardness of water is due to the presence of dissolved salts of calcium and magnesium. Water in which soap gives lather readily is called soft water.

Repeat the experiment by adding soap after boiling the above three solutions. What do you observe?

The hardness of water containing Calcium or Magnesium bicarbonates is removed during boiling. This type of hardness of water is known as *temporary hardness*.

The hardness of water containing the chlorides and sulphates of calcium and magnesium is not removed even after boiling. This is *permanent hardness*.



Hardness of Water

Hard water is formed due to the dissolution of the salts of calcium and magnesium present in soil and rocks as rain water seeps through the soil. Hard water does not give easy lather with soap because the salts of calcium and magnesium react with soap to form insoluble salts.



Heavy water

Do you know that there is heavy water in addition to hard water and soft water? Heavy water is water molecules containing deuterium, the isotope of hydrogen, instead of ordinary hydrogen atoms. This is used in nuclear reactors.

Permanent hardness of water can be removed only by using certain chemicals.

The temporary hardness of water is removed during boiling of water. This is due to the decomposition of bicarbonates during heating. But permanent hardness cannot be removed like this. We can identify hard water by analysing samples of water collected from different sources.

If clothes are washed using tap water, well water, boiled water or river water, will it give the same result?

Discuss the difficulties of washing clothes using hard water.

Water and Gases

Which gas do creatures use for breathing?

Which gas is used by plants to produce food?



Aquarium

How do aquatic creatures and aquatic plants get these gases?

Why is air continuously introduced into the water in an aquarium?

How does the fish in an aquarium get oxygen to breathe?

Gases like oxygen and carbon dioxide dissolve in water.

Aquatic animals and plants make use of the oxygen dissolved in water. Water gets polluted as the amount of oxygen in it decreases.

The wastes dumped into rivers and ponds decay using the oxygen dissolved in them. This depletes the amount of oxygen and results in the destruction of aquatic life.

You can investigate any such pollution of water bodies in your locality.

What are the different methods to increase the amount of dissolved oxygen in water? Find out.



A scene of water pollution

Water Pollution

Water pollution is a burning issue now-a-days?

Isn't it a social hazard?

Who is responsible for this?

Can you list the various activities that cause water pollution?

- Dumping of wastes in water resources
- Rampant use of fertilizers
- Excessive use of detergents
- Insecticides getting mixed with water
-
-

Identify more situations and prepare a seminar paper.

Scarcity of drinking water is one of the major issues faced by the mankind. Existing water resources are getting polluted day by day. This puts the very existence of life on earth in danger. Isn't it the obligation of every one of us to adopt measures to prevent water pollution? What are the possible solutions?

Will rain water harvesting help to solve water scarcity? What are the possible remedial measures for this? Prepare a note and present it in the classroom.



Rain water harvesting - a model



Significant learning outcomes

The learner can

- identify and explain the properties of water such as boiling point and melting point.
- identify the ability of water to contain heat and apply it in daily life.
- explain and utilise the anomalous expansion of water.
- identify the concept of surface tension and apply it in daily life.
- perform experiments for separating the components of water.
- conduct experiments for the formation of water by combining hydrogen and oxygen.

- identify the chemical reactions of water as a chemical compound and give explanations through experiments.
- analyse the causes of hardness of water and rectify them.
- analyse the causes of water pollution and adopt methods to avoid water pollution.



Let us assess

1. When water is heated at its boiling point or melting point, its temperature does not change.
 - a) What is meant by boiling point and melting point?
 - b) What are the boiling and freezing points of water?
 - c) Why is there no change in temperature?
2. A definite quantity of water and coconut oil are heated in separate test tubes using the same amount of heat.
 - a) In which case does the temperature increase slowly?
 - b) What is the reason for this?
 - c) Write any one practical application of this property.
3. 100 mL each of coconut oil and water are taken in two beakers and kept in the freezer.
 - a) What difference can be observed in their volumes during freezing?
 - b) What do you infer from the observation?
 - c) When water is frozen in glass bottles, it is advised not to fill the bottles completely. Explain the reason.
4. Soap decreases the surface tension of water.
 - a) What is surface tension?
 - b) How does the decrease in surface tension benefit washing of clothes?
5. Surface tension tends to minimise the surface area of a liquid. Suggest an experiment to prove this. (Follow the pattern: Required materials, Procedure, Expected observation).
6. Providing excess food for fish in an aquarium is a threat to its survival. Justify.

7. Some substances when dissolved in water cause hardness of water.

a) Which of the following substances cause hardness of water?

Sodium chloride, Calcium bicarbonate, Calcium carbonate, Calcium sulphate, Magnesium sulphate, Calcium chloride, Magnesium carbonate

b) The hardness due to which of the above salts cannot be removed by boiling?



Extended Activities

(1) Take some sand in a vessel and keep some calcium carbide (CaC_2) pieces above it. After spreading some more sand place ice pieces. Now ignite the ice carefully.

What do you observe? What can be the reason?

(Water reacts with calcium carbide to form acetylene gas and calcium hydroxide. The combustible substance is acetylene gas.)

Calcium carbide + Water \rightarrow Calcium hydroxide + Acetylene

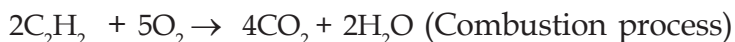
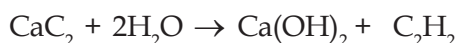

(2) Perform experiments using litmus paper and pH paper in different samples of water collected (well water, tap water, pond water, rain water, distilled water, sea water etc.) and record the observations.

Collect these samples in equal amounts in soft drink bottles, mix well after adding the same quantity of soap and check whether they are hard water or not.

(3) What are the methods to be adopted for purifying polluted water for drinking purposes? Explain those you know.

(4) Let's construct a Water Voltmeter :

Substances required :

9 V Alkaline battery - 1

Plastic ice cream cup - 1

Drawing pin - 2

Micro test tube - 2

Procedure

Place the middle of the cup above the battery and mark the points where it touches the terminals. Pierce drawing pins from the bottom of the cup through the markings. Now take water mixed with a little of an acid in the cup and place it in such a way that the drawing pins touch the terminals of the battery. See what happens. Fill two micro test tubes with water and place them inverted above the pins. Observe what is happening. What is your inference?

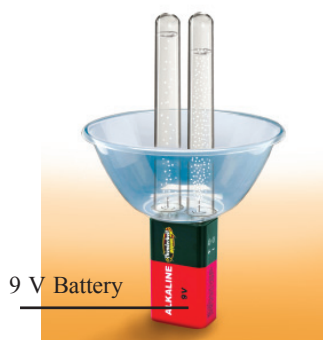

- (5) Fill an injection syringe with water about to boil. Pull the piston backwards after tightly pressing the nozzle with fingers. What do you observe? Can you explain the reason?



Fibres and Plastics



We live in an era of tremendous progress in the field of science and technology. We see a variety of substances around us that are available for improving our life style. A close examination will reveal that most of them are contributions of chemistry. Chemistry has paved way for amazing changes through the maximum utilization of natural resources and also by producing a variety of modern materials.

Identify the contributions of chemistry in different fields and prepare a seminar presentation.

Polymers

As you know, cotton, silk, wool, jute etc., are the substances used for producing clothing since ancient days. All of them along with other familiar substances like fibre, rubber etc., are made of molecules belonging to a group called **polymers**. Polymers are macromolecules formed by the combination of large number of simple molecules (monomers).



Life originated through polymers

Polymers were formed when life had originated on the earth. Protein, a polymer formed by the combination of amino acids about 400 crore years ago, was the basis of life. All the proteins, DNA, starch, cellulose etc., found in living beings belong to the category of polymers. These are called **biopolymers**. These and the polymers mentioned at the beginning of this chapter are **natural polymers**. Polymers like nylon, rayon, polythene and PVC made in science laboratory, belong to the category of organic polymers. These are called **synthetic polymers**.

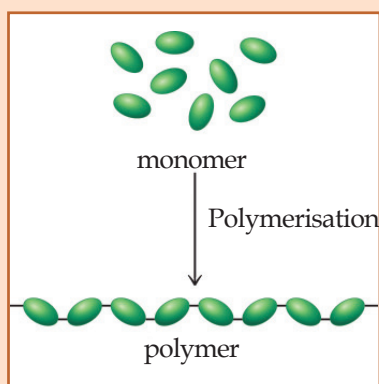

Monomer molecules combine to form polymers just like a necklace being formed by the combination of various identical beads.

For example, molecules like glucose and amino acids are monomers. Starch and protein are respectively the polymers formed from them.

Based on their physical nature, polymers are mainly classified into fibre, plastic and rubber.

- Fibres are the polymers suitable for the manufacture of strong threads.
- Plastic is the polymer which can be moulded into different shapes.
- Rubber is an elastic polymer.
-

Man-made or Synthetic fibres

Natural fibres like cotton and silk, are not sufficient to meet all our needs. They have a number of merits but they do not possess specific desirable properties. Evaluate the natural polymers used for the manufacture of clothes and list their merits and demerits. Table (17.1).

Merits	Demerits
<ul style="list-style-type: none"> • Comfortable to wear • • • 	<ul style="list-style-type: none"> • Less available • • •

Table 17.1

In order to overcome the demerits, several synthetic polymers have been prepared through chemical methods. The synthetic polymers like nylon and terylene widely used nowadays in textile industry are man made polymers belonging to the category of fibres.

What are the general characteristics of these synthetic fibres? Make a list.

- Cheaper than natural fibres.
- High durability.
- Wrinkle free.
- Can dry easily on getting wet.

- -----
- -----

Along with the merits, synthetic threads have demerits too. Tick (✓) the correct property that applies to synthetic threads in comparison to natural threads.

- Aeration (High/Low)
- Ability to absorb water (High/Low)
- For hot weather (Suitable/Not suitable)
- Inflammability (High/Low)

Can we overcome these limitations?

Synthetic fibres are generally used by blending them with natural substances like cotton. What may be the reason? Find out.

Plastics

Plastics are polymers having properties different from those of fibres. These are substances that changed the very face of human life. Plastics are synthetic polymers. Different types of plastics are used for manufacturing a number of products from household utensils to artificial heart valves. No other substances have so diverse a use as that of plastics. Plastics with diverse properties have been prepared nowadays making them more useful.



Rubber

Rubber is a natural polymer with elastic properties. Rubber is isolated from the latex, obtained from rubber tree. Rubber is a polymer formed by the combination of the monomer molecules, isoprene.

Synthetic polymers with the properties of rubber have been developed. These are called synthetic rubbers. Neoprene, Thiokol, Buna-S, Buna-N etc., belong to this group.



Nylon and Rayon

Nylon is the first artificially prepared fibre. Nylon got its name from the names of the cities, New York and London. Nylon was first marketed in these cities. Rayon is a semi-synthetic fibre known as artificial silk. Rayon, having similar properties of natural silk, is used for the manufacture of 'silk clothes'.



A brief history of plastics

Plastic got its name from the Greek word 'plastikos' which means 'with alterable shape'. 'Parkesine', prepared by Alexander Parkes in 1856 was the first substance analogous to plastic. The first artificial plastic was Bakelite prepared by the Belgian chemist Leo Baekeland in 1909.



What are the characteristics of plastics known to you?
List them.

- -----
- -----
- -----

Some situations in which plastics are used have been given in the table. Find out and write which property of plastic is used in each situation. Expand the table by including more situations. (17.2).

Situation	Characteristic
To insulate electric conductors	Not a conductor of electricity
To make handles of kitchen utensils	
To store chemical substances	
To make water tanks	
To make household utensils	

Table 17.2



Structure of Plastics

Different plastics have different molecular structure. Thermoplastics are called linear polymers. These are formed by the linear combination of monomers. Thermosetting plastics have a structure in which the monomer units are cross-linked in different directions. The structural difference between these two is the reason for their difference in behaviour towards heat.



Linear Polymer
(Thermoplastic structure)

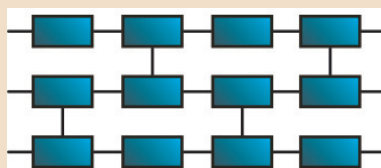

Cross-linked Polymer
(Thermosetting Plastic Structure)

Thermoplastic and Thermosetting plastic

Are plastics with the same property used for all purposes?

Have you seen plumbers using PVC pipes by heating and cooling? What is the peculiarity of these plastics? Can we use PVC for making the handles of pressure cookers and iron box? Observe the changes by heating a piece of PVC and old switches.

Plastics can be classified into two types based on the changes that occur while heating. The plastic that gets softened on heating and hardened on cooling is **thermoplastic**. This process can be repeated any number of times.

The plastic which remains soft when heated during its manufacture, and gets hardened permanently on cooling is **thermosetting plastic**. Once hardened, they cannot be remoulded by heating.

What can be the reason for this behaviour of plastics?

Thermoplastics undergo physical change on heating.

Thermosetting plastics on heating undergo chemical change along with physical change.

Some plastics we use in our day-to-day life and their uses are given in Table 17.3.

Pollution due to plastic

Plastic, once considered as a wonderful substance, has now become a dreaded substance to be avoided everywhere. Restrictions on the production and use of plastics have been enforced world-wide. In our country the use of plastics has been banned in a number of places. You also may be aware that steps have been taken to make hospitals, campuses, zoos and public places plastic free. This is because plastics do not undergo biodegradation like other substances.

What are the situations in which plastic materials become harmful? Think.

- Leads to environmental pollution when discarded carelessly
- -----
- -----
- -----

Can plastics be banned completely?

Haven't the use of plastics given various benefits to mankind? Find out the role played by plastics in the following:

- Forest conservation
- Household utility
- Health
- Construction work

Thermoplastic	
Name	Uses
Polythene	For the manufacture of different packets, tubes, containers etc.
Poly vinyl chloride (PVC)	For the manufacture of electrical wirings, plumbing, shoes, hand bags, raincoats, bottles, furniture etc.
Thermosetting plastic	
Bakelite	For the manufacture of plugs, switches, buttons, handles of electrical utensils and kitchen vessels etc.
Melamine - formal dehyde resin	For the manufacture of unbreakable crockery

Table 17.3



A scene of plastic wastes



Different images of pollution due to plastics can be downloaded from the internet.

Let us practise the 4 R's

Let us practise the 4 R's to reduce the use of plastics to the maximum extent as well as to avoid the pollution caused by plastics.

What are the 4 R's?

Reduce – Plastics

Reuse – Plastics

Refuse – Plastics

Recycle – Plastics



Plastic and Micron

The thickness of plastic is expressed in micron unit. 1 micron = 10^{-6} metre (0.000001 m). Since plastic with less than 40 micron thickness is easily breakable and may be discarded, its use is restricted in many places.

Energy from Plastic

When carry bags and bottles made of polythene and polypropene are burned completely at high temperature in the presence of excess of air, along with CO_2 and H_2O , a large amount of energy is released.

When hydrocarbon polymers are heated in the absence of air under high temperature and pressure, the polymer molecules decompose to form products which can be used as fuels. The method of producing electricity using this gaseous fuel is already in practice.

Assess the uses of plastic as well as the issues raised by them. Let's also conduct a debate on the topic 'Plastic - a boon or a curse'. Is plastic the real culprit or the human beings who use it illogically? What measures can be proposed to reduce pollution due to plastics?

- Avoid disposable plastic products
- During functions, use glass/ceramic/steel utensils or natural substances
- Use paper, cloth and plant materials, instead of plastic for decorations
-

Find out still more possibilities and present them in a seminar.



Recycling Symbols

For effective plastic recycling, it is necessary to identify the type of a particular plastic. Different plastics have been given certain recycling symbols. Triangular arrows with numbers from 1 to 7 printed on them are used as symbols.



PETE

Polyethylene terephthalate



HDPE

High density Polythene



V

Polyvinyl chloride



LDPE

Low density Polythene



PP

Polypropene



PS

Polystyrene



OTHER

Others



Significant learning outcomes

The learner can

- identify polymers and explain their molecular structure.
- classify natural polymers and synthetic polymers.
- compare natural polymers and synthetic polymers and assess their merits and demerits.
- identify the characteristics and uses of different plastics and choose them as and when required.
- distinguish between thermoplastics and thermosetting plastics.
- explain the merits and demerits of plastics and use them judiciously in daily life.
- identify the causes and effects of pollution due to plastics and involve in awareness activities.



Let us assess

1. Polymers are macromolecules formed by the combination of many monomers.
 - a) How are polymers classified?
 - b) Classify the following:

Cotton, Wool, Nylon, Silk, Terylene, Jute, Polyester

2. Some monomers and polymers are given in the following table:

Monomer	Polymer
Ethene	Polyethene (Polythene)
Propene	Polypropene
Styrene	Polystyrene
Vinyl chloride	Polyvinyl chloride

- a) What is meant by the terms 'monomer' and 'polymer'?
- b) What is the common system of nomenclature of polymers?

Analyse the table and find out.

3. Natural fibres and synthetic fibres are used in the field of textile manufacturing.
 - a) Compare their merits and demerits and tabulate.

- b) Which of these clothes is most suited for the following situations? Give reason.
 - i. While cooking in the kitchen
 - ii. To wear during summer
- 4. You know what thermoplastics and thermosetting plastics are.
 - a) Which of these plastics cannot be recycled?
 - b) You might have noticed that those who collect old plastics do not accept certain type of plastic articles. What are they? What may be the reason for this?
- 5. Some argue that plastics are to be completely banned as they cause environmental pollution. What is your view?
- 6. The school science club has decided to conduct a poster propaganda for creating awareness about pollution due to plastics. Prepare some posters for this.
- 7. What suggestions can you propose to realise the concept of 'plastic waste-free school'? List your findings.



Extended Activities

- 1. Collect different threads of equal length and thickness (cotton, jute, nylon, polyester etc.) and perform the following activities.
 - a) Hang weights on hooks attached to the threads. Increase the weights step by step. Find out which thread has the capacity to withstand more weight (tensile strength).
 - b) Cut different threads and ignite them. Observe the difference in their combustion property. Find out those having similar properties.
- 2. A variety of articles made of plastic are used daily in your house for different purposes.
 - a) What are the different purposes? What are the different articles? Prepare a note.
 - b) How are these disposed after use? Is this done in the correct way?
 - c) Try to find out the amount of plastic abandoned after use at home in one month.

3. Collect a piece of PVC pipe, a discarded switch, handle of a kitchen utensil and a polythene packet. Heat them slowly in a metallic vessel and observe. Analyse the changes happening to them while heating and cooling. Can you identify the type of plastics to which they belongs?
4. Many articles made of plastics can also be made using glass, ceramics, steel etc., and by some natural materials like plantain leaf, spathe etc., thereby reducing the use of plastics. Identify the possibilities for this and conduct an exhibition in your school.



Reflection of Light in Spherical Mirrors



The child is astonished on seeing his own image in the mirror in the hall.

- Have you ever had such experiences?

Look at your face on both the sides of a new steel spoon. What do you see? Record in your science diary your observations in each of the following situations.

- How does the image appear on the rear side of the spoon?
- What about the image on the inner surface of the spoon?

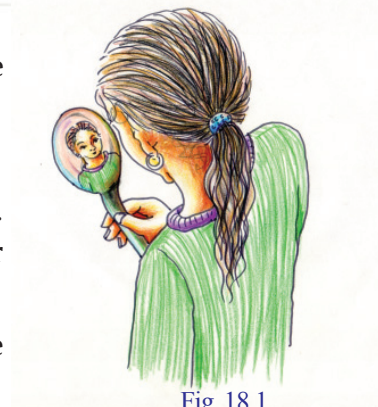

Fig. 18.1

A child observing the image on the rear side of the spoon.

- Write down the special features of the image on the spoon in relation to the shape of the reflecting surface.
- How do these images differ from that seen on a plane mirror?

Images are formed not only on plane mirrors but also on smooth curved surfaces.

Spherical mirrors

Cut off a small portion of a rubber ball as shown in figure 18.2 (a). Make a reflecting surface by affixing a silver paper on its inner surface as shown in figure 18.2 (b).

Allow light rays from a torch to fall on this surface.

Are you able to converge the reflected rays of light on to a wall?

Repeat the experiment by affixing silver paper on the outer surface of the cut off portion as shown in figure 18.2 (c). Are you able to converge the reflected rays of light on a wall?

- What is the peculiarity of the reflecting surfaces of these mirrors? Note them down in your science diary.

Spherical mirrors are mirrors in which the reflecting surface is a part of the sphere.

Concave mirror is a mirror in which the reflecting surface is curved inwards. Convex mirrors are mirrors in which the reflecting surfaces are curved outwards.

Let's familiarise with the technical terms associated with spherical mirror.

1. Centre of Curvature

Centre of a sphere of which the mirror is a part, is the centre of curvature of the mirror. In figure 18.3 (a) and 18.3 (b), C indicates the centre of curvature.

Any line drawn from the centre of curvature to the mirror is normal to the mirror.

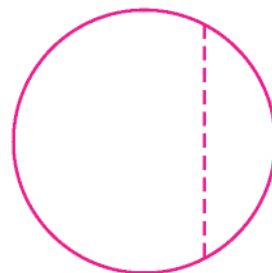
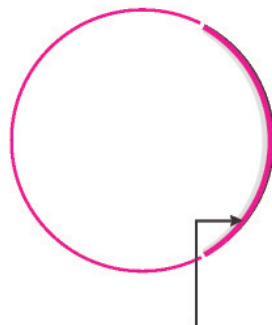
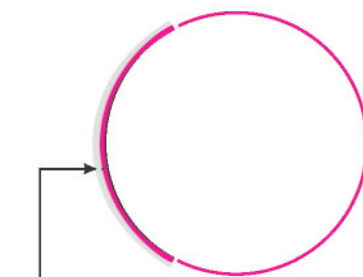

Fig. 18.2 (a)



silver paper
affixed on the
inner surface

Fig. 18.2 (b)



silver paper
affixed on the
outer surface.

Fig. 18.2 (c)

CP, CA and CB, which are marked on the figures 18.3 (a) and 18.3(b), are normal to the mirror.

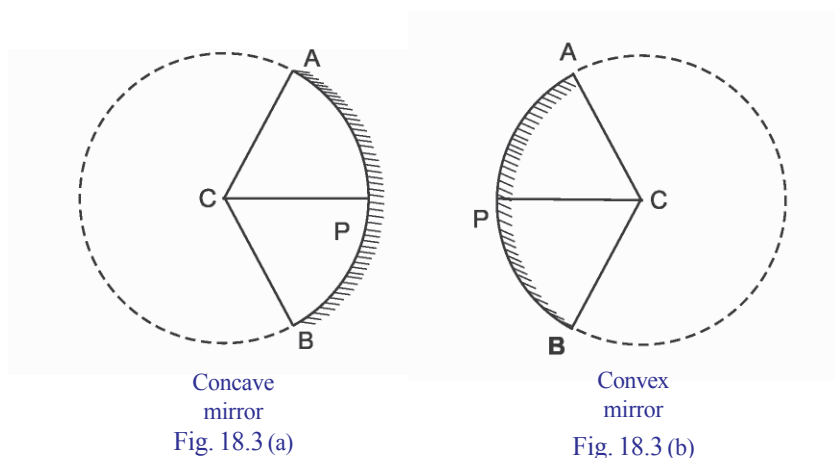

2. Radius of curvature

Radius of curvature (R) of a mirror is the radius of the sphere of which it is a part.

Distance from the centre of curvature to the reflecting surface of a mirror is the radius of curvature. In the figures, CP, CA and CB indicate the radius of curvature.

3. Aperture

Aperture of a mirror is the reflecting surface of the mirror.

4. Pole

Pole of a mirror is the midpoint of the reflecting surface of the mirror. It is represented as P in the figure.

5. Principal axis

Principal axis of a mirror is the straight line connecting the pole of the mirror and the centre of curvature of the mirror.

Reflection from a spherical mirror

You have already learned the laws of reflection related to plane mirrors. Write them down.

- Incident ray, reflected ray and the normal at the point of incidence are in the same plane.
-

The laws of reflection are applicable to spherical mirrors as well. Let's try to understand it through an activity.

Take a concave mirror of known radius of curvature with its

midpoint marked. Insert half the portion of the mirror in a cardboard or thermocol sheet as shown in the figure.

Fix the printout of a protractor in front of the mirror as shown in the figure. (You can also draw it using a protractor). Draw the axis to the midpoint which is already marked and mark the centre of curvature (C) on it. Now allow the light ray (AO) from a laser torch to fall on the mirror at a suitable angle, along the surface of the thermocol.

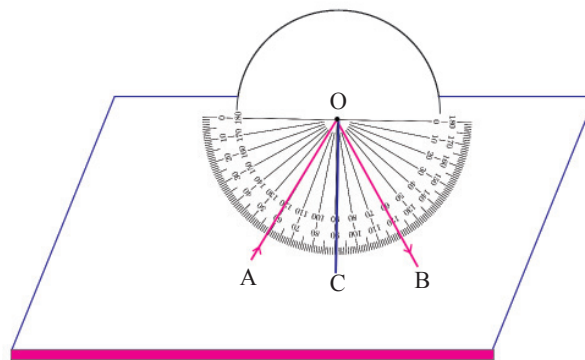

Fig. 18.4

Draw the path of the reflected ray OB. Find out the angle of reflection and write it down.

Angle of incidence, $i = \angle AOC = \dots\dots\dots$

Angle of reflection, $r = \angle COB = \dots\dots\dots$

Repeat the experiment by changing the angles of incidence. Record in the table the values of angle of incidence and the angle of reflection in each instance.

Serial number	Angle of incidence (i)	Angle of reflection (r)
1	30°	
2	45°	
3	60°	

Table 18.1

Analyse the table and write down your inference in the science diary.

Repeat the experiment by using a convex mirror and write down your findings in your science diary.

Angle of incidence and angle of reflection are equal in spherical mirrors.

Focus and focal length of a spherical mirror

Hold a concave mirror against the sun when there is excess of sunlight. Hold a paper sheet in front of the mirror and adjust the distance between them and focus the light on the paper. Don't you get a very bright spot on the paper?

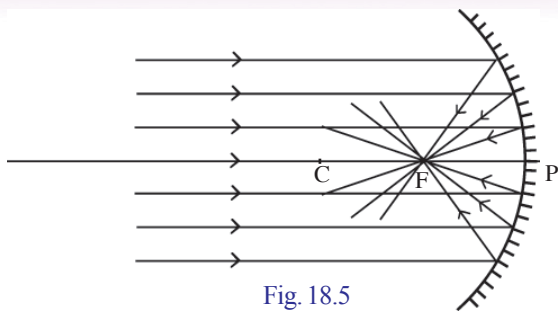

Fig. 18.5

You might have seen how the light rays focus. Figure 18.5 shows how the light rays from a distance fall on a concave mirror and how they get reflected.

- How do the incident rays travel?
- What about the path of the reflected rays?

Principal focus of a concave mirror

Rays of light incident on a concave mirror, parallel to the principal axis, pass through a fixed point on the principal axis after reflection. This point is the principal focus (F) of the concave mirror.

Let's find out the principal focus of a convex mirror. Draw a straight line through the middle of a thick thermocol sheet. Make a small gap in the sheet in such a way that the gap is perpendicular to the line. Insert half a portion of a convex mirror into this gap.

Mark the midpoint of the mirror. Make sure that the straight line drawn on the sheet passes through the midpoint. As shown in the figure 18.5, allow light rays from two laser torches to fall on the mirror in such a way that they are parallel to the principal axis and are equidistant from the line.

Draw the path of the reflected rays of light.

- What happens to the path of rays after reflection?
- Are the reflected rays converging to a point?
- Take the mirror away and trace the path of the reflected rays backwards. Are they converging at a point?

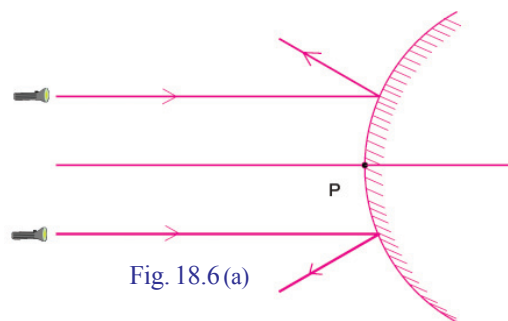

Fig. 18.6(a)

From figures 18.6 (a) and 18.6 (b) try to understand how the reflection of parallel rays falling on a convex mirror can be depicted.

Take a look at the principal focus marked F in figure 18.6 (b).

- It is not possible to make the rays of light fall on a screen by focusing them at the principal focus of a convex mirror. Hence the principal focus of a convex mirror is said to be virtual.

But the principal focus of a concave mirror is real. Write down its reason in your science diary.

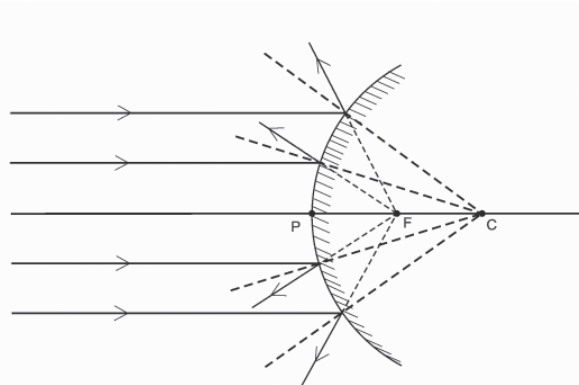

Fig. 18.6(b)

Principal focus of a convex mirror

Rays of light incident on a convex mirror parallel to the principal axis appear to come from a fixed point on the other side of the mirror. This point is the principal focus of the convex mirror.

On the basis of the information you have gathered write down the differences between principal foci of concave and convex mirrors and complete the table given below.

Concave mirror	Convex mirror
	• Virtual
In front of the mirror	•

Table 18.2

Focal length (f)

Distance from the pole of a mirror to its principal focus is the focal length. It is indicated using the letter f .

In the figures 18.5 and 18.6 (b) PF indicates the focal length.

$$PF = f$$

The focal length (f) of a spherical mirror is half the radius of curvature (R) of the mirror.

$$f = \frac{R}{2}$$

- The radius of curvature of a spherical mirror is 20 cm. Calculate its focal length.

$$R = 20 \text{ cm}$$

$$f = \frac{R}{2} = \frac{20}{2} = 10 \text{ cm}$$

- The focal length of a convex mirror used as rear view mirror in a bus is 0.6 m. Find its radius of curvature.

Focal plane

Rays of light coming from infinity, making different angles with the principal axis get focused at different points. The plane formed by these points is perpendicular to the principal axis and passes through the principal focus. This plane is the focal plane.

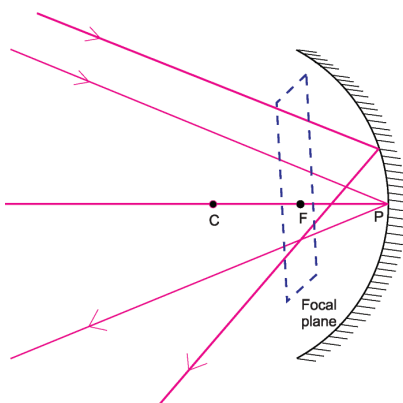

Fig. 18.7

Images formed by spherical mirrors

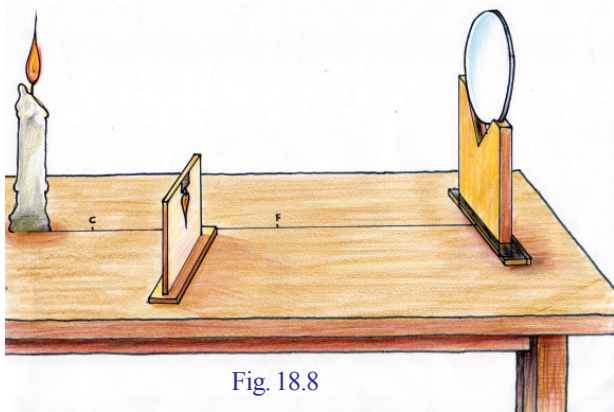

Fig. 18.8

Let's try to understand the position, nature and size of an image formed by objects kept at different positions in front of a concave mirror.

Draw a straight line on a table. At one end of the line, fix a concave mirror of known focal length on a stand. Mark the centre of curvature and the principal focus on the line. Place a lighted candle on the principal axis at a small distance from the centre of curvature. Place a screen in front of the mirror and adjust

its position so as to get a clear image of the candle on the screen.

- On placing the screen in which position in front of the mirror, do you get a clear image? What is the position of the screen when a clear image is obtained on it?
- Is the image erect or inverted?
- Is the image diminished or magnified?

Similarly place the candle at different positions and find out the position of image, size and features and complete the table 18.3.

Sl. No.	Position of the object	Position of the image	Features of the image
1	At infinity		
2	Beyond C		
3	At C		
4	Between C and F		
5	At F		
6	Between F and P		

Table 18.3

Ray diagrams of spherical mirrors

We can understand the position of image and its features by means of ray diagrams. For this purpose, we take into consideration only two rays from among the many rays of light starting from a point on the object.

How do we draw the path of the reflected ray of light that is incident on a spherical mirror?

Take a look at the figure.

OA is a ray of light incident on a concave mirror. CA is the normal drawn at A. Draw the path of the reflected ray of light in accordance with the law of reflection.

Likewise, we can draw the reflected rays of light incident at different points of a concave mirror or a convex mirror, based on the laws of reflection.

Complete the following ray diagrams by drawing the normal and reflected rays.

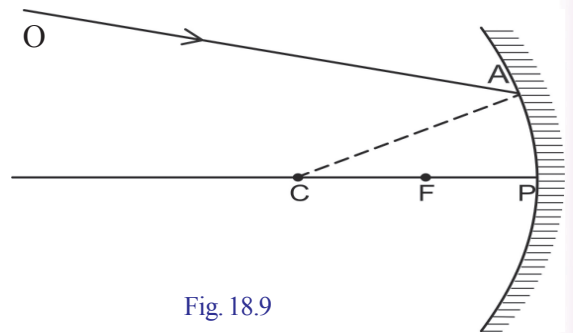

Fig. 18.9

Ray of light incident on a mirror and parallel to the principal axis

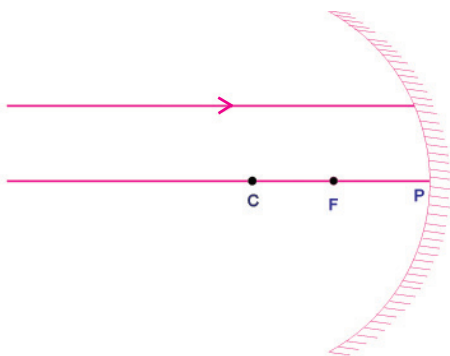

Fig. 18.10(a)

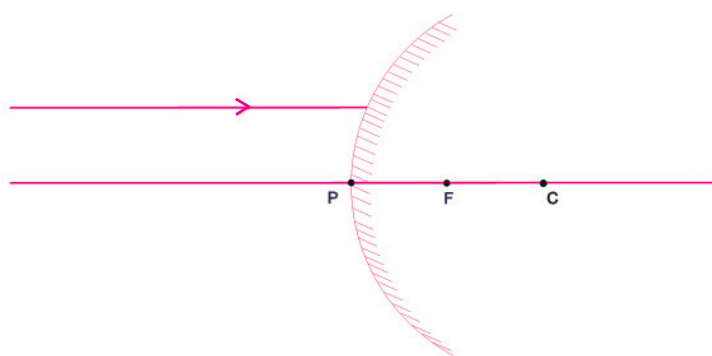

Fig. 18.10(b)

Ray of light incident through the principal focus of a mirror

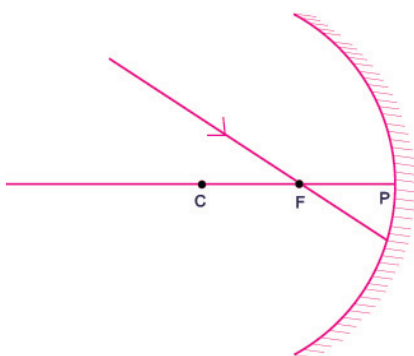

Fig. 18.11(a)

Ray of light incident on a mirror and directed to the principal focus

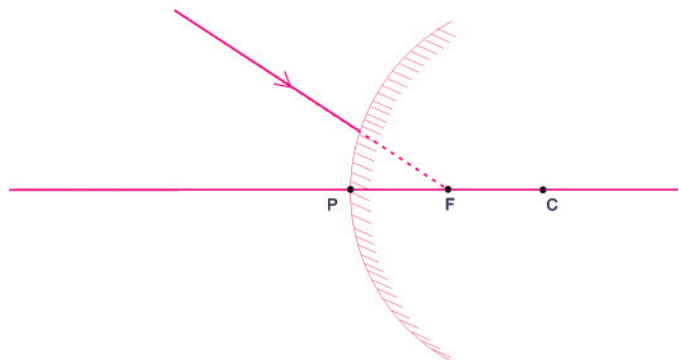

Fig. 18.11(b)

Ray of light incident through the centre of curvature of a mirror

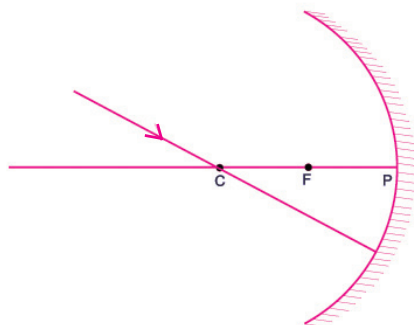

Fig. 18.12(a)

Ray of light directed to the centre of curvature of a mirror

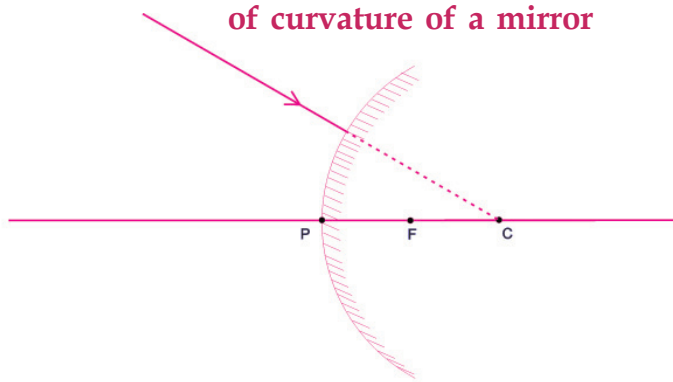

Fig. 18.12(b)

Ray of light falling obliquely at the Pole

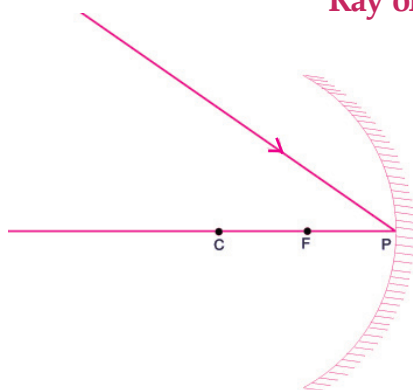

Fig. 18.13(a)

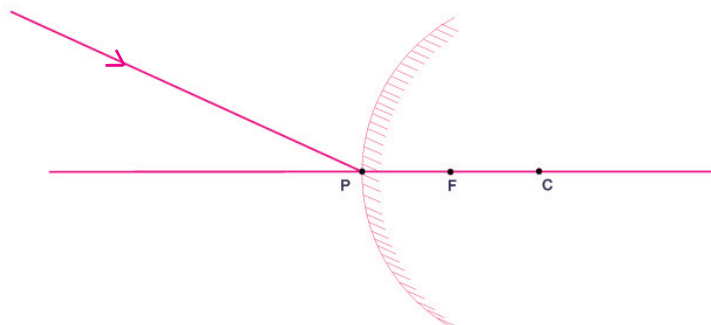

Fig. 18.13(b)

When a ray of light falls obliquely at the pole, the principal axis itself is the normal. Hence you don't have to draw another normal.

Record the information gathered through the ray diagrams.

Path of incident ray	Path of reflected ray of light	
	Concave mirror	Convex mirror
Parallel to the principal axis		
Through the principal focus/ to the principal focus		
Through the centre of curvature/ to the centre of curvature		
Incident obliquely at the pole		

Table 18.4

Ray diagrams of images formed by spherical mirrors

Using ray diagrams, let's try to describe the position of image and its features when objects are placed at different positions in front of a spherical mirror.

For this, we can make use of any two rays of light given below.

- Ray of light incident on a mirror parallel to the principal axis.
- Ray of light incident on a mirror through the principal focus.
- Ray of light incident on a mirror through the centre of curvature.
- Ray of light incident at the pole making a definite angle with the principal axis.

A. Formation of images in concave mirrors

1. Object at infinity

Position of image is at F.

Features of image

- Real
- Inverted
- Diminished

You might have found out the position and features of image formed at the following instances. Complete the following ray diagrams and note down the position of images and their features.

2. Object beyond C

Position of the image is

Features of image:

-
-
-

3. Object at C

Position of the image is

Features of the image

-
-
-

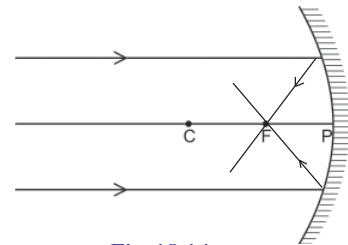

Fig. 18.14

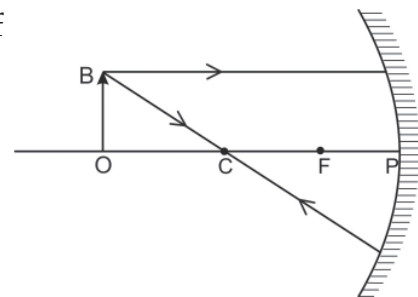

Fig. 18.15

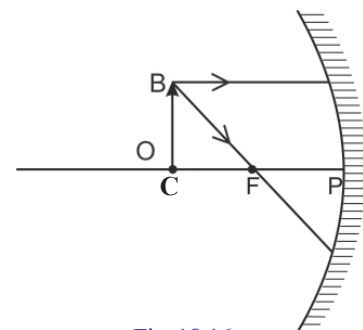

Fig. 18.16

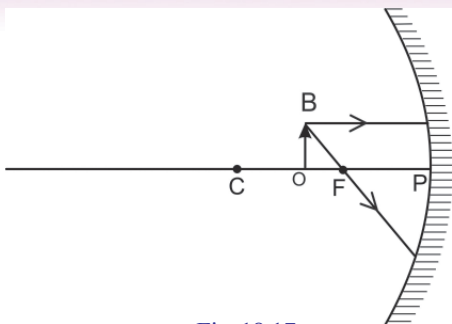

Fig. 18.17

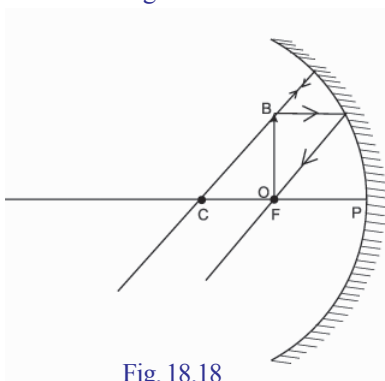

Fig. 18.18

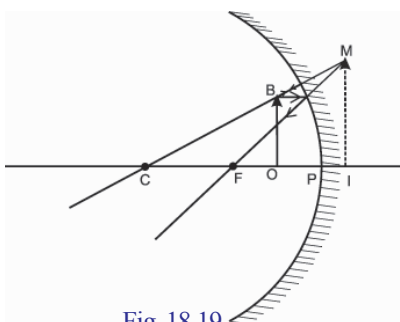

Fig. 18.19

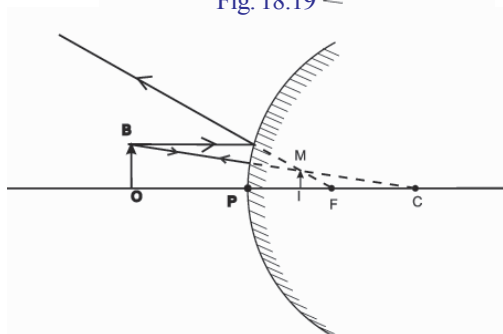

Fig. 18.20

4. Object between C and F

Position of the image is

Features of the image

-
-
-

5. Object at F

In the experiment you conducted, did you get an image on placing the object at F? Take a look at the figure 18.18. What about the paths of the reflected rays of light? Record your findings in the science diary. The reflected rays of light are seen to go parallel. It is assumed that the image is formed at infinity.

6. When object is between F and P

Take a look at the position of image in the depiction.

Position of the image is

Features of the image :

-
-
-

Do convex mirrors also form images like a concave mirror?

B. Formation of images in a convex mirror

Position of the image is

Features of the image

-
-
-

The image formed by a convex mirror is always virtual, erect and diminished. Whatever may be the position of the object, the position of image is always between the pole of the mirror and the principal focus.

You might have understood about the images formed by spherical mirrors. Aren't you convinced that some of them are real and some are virtual? Discuss the difference between real and virtual images and complete the table 18.5.

Real image	Virtual image

Table 18.5

You might have understood about the virtual images made by concave and convex mirrors. Now let us take a look at the differences between the images.

- The virtual image made by a concave mirror is always enlarged.
- The virtual image made by a convex mirror is always diminished.

Magnification

Take a look at the figure showing the formation of image by a concave mirror.

Accurately measure the height of the object, $h_o = OB$ and the height of image $h_i = IM$

height of object, $h_o = \dots$ cm

height of image $h_i = \dots$ cm

Can you now calculate the ratio of height of the image to the height of the object?

$$\frac{\text{Height of the image}}{\text{Height of the object}} = \frac{h_i}{h_o}$$

Magnification is the ratio of height of the image to the height of the object. It is the number that indicates how many times the size of the object is the size of the image.

$$\text{Magnification, } m = \frac{h_i}{h_o}$$

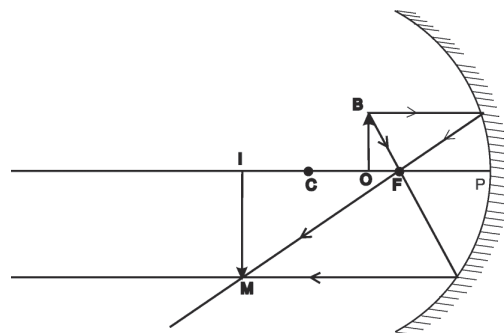

Fig. 18.22

While calculating the magnification, the measurement taken upwards from the principal axis is considered positive and the measurements downwards are considered negative. Magnification is a physical quantity having no unit.

Calculate the magnification if an object of height 3 cm kept in front of a concave mirror, gives a real image of size 6 cm.

$$h_o = 3 \text{ cm}$$

$$h_i = -6 \text{ cm}$$

$$\text{Magnification, } m = \frac{h_i}{h_o} = \frac{-6}{3} = -2$$

1. a) Observe the figure 18.22 and calculate the magnification.

b) Calculate the height of an object when it gives an image of height 4 cm when it is placed at the same place in front of the mirror.

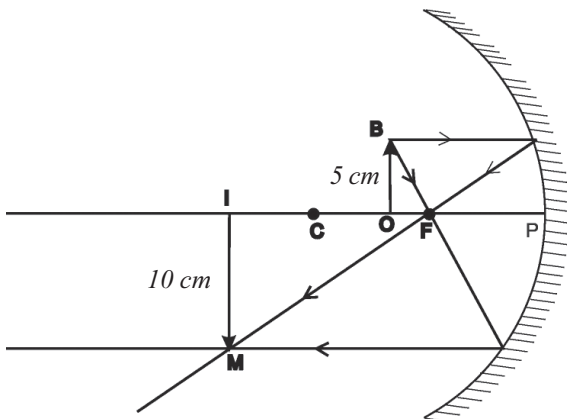

Fig. 18.22

Uses of spherical mirrors

A) Uses of concave mirrors

- Shaving mirror (Fig. 18.23)
- Make up mirror (Fig. 18.24)
- Head mirror used by doctors
- In film projectors

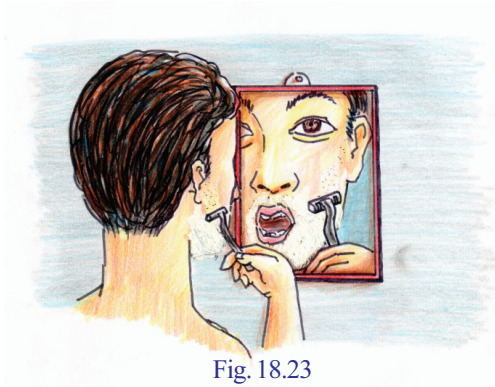

Fig. 18.23



Fig. 18.24

B. Uses of convex mirrors

- Used as reflectors in street lamps.
- Used as rear view mirrors by drivers for viewing vehicles from behind. These mirrors have a wide field of view compared to that of plane mirrors. Hence, they can help in avoiding accidents to a certain extent.

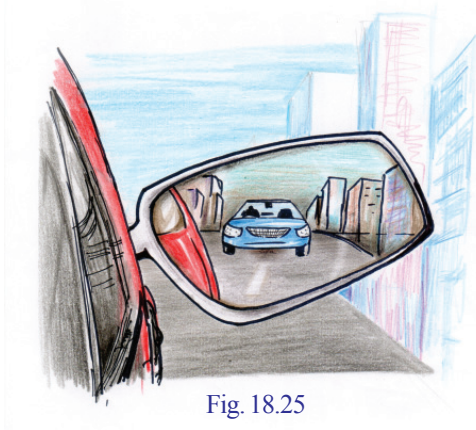

Fig. 18.25

- Big convex mirrors help in viewing vehicles coming beyond curves, thus minimising accidents.



Significant learning outcomes

The learner can

- explain features of images formed by different types of spherical mirrors.
- engage in experiments by understanding that the laws of reflection in plane mirrors are applicable to spherical mirrors as well.
- draw ray diagrams by distinguishing the principal foci of convex and concave mirrors.
- solve mathematical problems by understanding the relationship between radius of curvature and the focal length of spherical mirrors.
- explain the formation of images, position of images and their features and can engage in related experiments.



Concave mirrors in search lights

Concave mirrors or parabolic mirrors are used in search lights. The rays of light from a source of light kept at the principal focus of a concave mirror, travel a long distance as parallel rays after reflection from the mirror. Search lights are used for locating persons who meet with accidents at night or in natural disasters as these lights can illuminate distant objects very well.

- draw ray diagrams showing the formation of images.
- explain magnification of mirrors and can solve related mathematical problems.
- make use of concave and convex mirrors in daily life.



Let us assess

- 1) Classify the following statements as to those related to concave mirrors and convex mirrors and tabulate them accordingly.
 - a) to view the face
 - b) as make up mirror
 - c) as rear view mirrors in vehicles
 - d) in solar concentrators
 - e) in periscopes
 - f) as shaving mirror
- 2) Calculate the radius of curvature of a convex mirror of focal length 12 cm.
- 3) A ray of light is made to fall on the pole of a concave mirror making an angle 30° with the principal axis.
 - a) What is the angle of reflection?
 - b) Justify your answer.
 - c) Draw the ray diagram.
- 4) Which type of mirror always gives an erect and diminished image?
- 5) A ray of light incident on a spherical mirror gets reflected along the same path. If so, show the light incident on the mirror.
- 6) OA is a ray of light incident on a concave mirror.
 - a) Draw the path of the reflected ray.

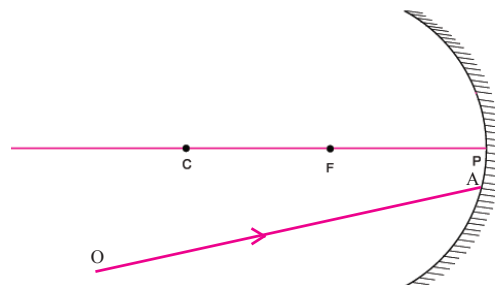

- b) On what basis did you mark the reflected ray?
- 8) Write down the type of mirrors that should be used for getting the following type of images.
- a) real and magnified
 - b) virtual and magnified
 - c) virtual and diminished
 - d) real and diminished
- 9) The height of an object kept 12 cm away from a concave mirror is 1 cm. Calculate the magnification if an image of height 2.5 cm is formed in front of the mirror.
- 10) a. Which type of mirror always give a virtual and erect image.
- b. Is this image magnified or diminished?



Extended Activities

1. Find out more situations in which concave and convex mirrors are made use of and write them down in your science diary.
2. Understand the change in the position and features of the image, when an object is moved from infinity to the principal focus and write them down in your science diary.
3. Observe the images of objects formed from the same side of a convex mirror and a plane mirror of the same size. Understand the differences and write them down in your science diary.
4. Using a concave mirror, direct the image of a distant object on a wall. Observe the image clearly. Then cover half the portion of the mirror and direct the image again on to the wall. Try to understand the differences.
5. Present a paper on situations where spherical mirrors are used in daily life.



Sound



Hope you noticed the child's soliloquy...

Have you ever thought how the mosquito makes sound while flying?

Sound is a form of energy which is familiar to us and is used for communication.

How is sound produced?

How does it reach our ears?

Why are all sounds not heard alike?

Let's examine.

Sound is a form of energy which gives us the sensation of hearing. If it is to be experienced, three components are essential.

Write down what those components are by observing figure 19.1.

1. Source of sound
- 2.
- 3.

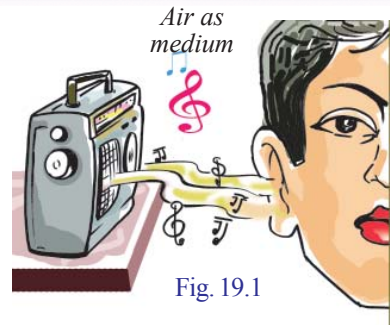

Source of Sound

You know how to make toys which produce sound, don't you?

Make such a toy and try to produce sound using it.

Certain situations and instruments that produce sounds are given in figure 19.2. Observe the figure and write them down.

You might have understood that sound is produced by sources of sound.

Classify them suitably and write down these sources of sound in table 19.1. Extend the table by finding out more such sources.



Fig. 19.2

Man-made sources of sound	Natural sources of sound
<ul style="list-style-type: none"> ● Chenda 	<ul style="list-style-type: none"> ● Vocal cord
<ul style="list-style-type: none"> ● 	<ul style="list-style-type: none"> ●

Table 19.1

How does a source produce sound?



Fig. 19.3



Fig. 19.4



Fig. 19.5

Try to do the activities given below.

- Tap the mouth of a glass or steel tumbler gently with a spoon. You will hear a sound. At the same time, gently touch the edge of the glass with your finger. What do you experience?
- Fill the tumbler with water and make the sound again by tapping with a spoon. What do you observe? Why are waves produced on the surface of the water?
- Excite a tuning fork with a rubber hammer and listen to the sound produced by the tuning fork. How is the sound produced? Immediately dip a prong of the tuning fork into the water in a vessel. What is your observation?

How is sound produced from materials ?

Write down your inferences on the basis of the activities you have done.

You would have understood that the sound is produced when the tumbler and the prongs of the tuning fork vibrate rapidly.

Sound is produced by the vibration of objects. Objects that produce sound are known as the sources of sound.

The sound produced from a source of sound would be the sum total of the vibration of the various parts related to the source. However, every sound source has a main vibrating part to produce sound. Observe the various sources of sound and find out the main vibrating part and the connected vibrating parts in each, and complete the table 19.2.

Source of sound	Main vibrating part producing sound	Connected vibrating parts
<ul style="list-style-type: none"> • the larynx • flute • chenda • violin 	<ul style="list-style-type: none"> • vocal cords • air column • • 	<ul style="list-style-type: none"> • throat, lips, etc • • •

Table 19.2

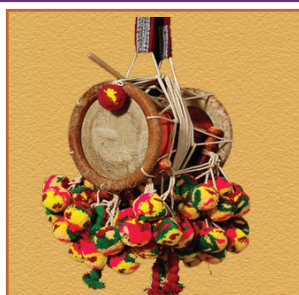

Try to listen to sounds by plucking the different strings of a violin. Are the sounds emitted from all the strings similar? What may be the reason for the difference in the sounds produced by *chenda* and *edakka*?

Let's take a look at some properties that bring in differences in sounds produced by different sources of sound.

Natural frequency

Suspend a small pebble from a string of about 50 cm long. Move this pebble slightly towards one side and release. We can see the pebble moving to and fro. You would have studied that such a motion is oscillation.

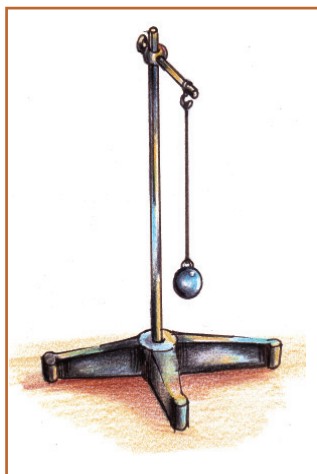

Fig. 19.6 Simple pendulum

This arrangement is known as a simple pendulum. The number of oscillations made by the simple pendulum in one second is its frequency. The unit of frequency is hertz (Hz).

Using a stop watch, find out the frequency of a simple pendulum of length 50 cm.

You have now found out the frequency of a simple pendulum.

Sl. No.	No. of oscillations (n)	Time (t)	Frequency (f) = $\frac{\text{No. of oscillations } (n)}{\text{Time } (t)}$
1	10		
2	15		
3	20		

Table 19.3

Change the length of the pendulum to 60 cm and 80 cm and tabulate the results to find out the frequency. What is the relation between the length of the pendulum and its frequency?

As the length of the pendulum increases, the frequency decreases.



See pendulum lab by opening PhET in the school resources in IT @ School, Edubuntu.

Dancing Light



Make a diaphragm by tying a piece of balloon on one end of a piece of pipe of about 10 cm in diameter. Fix a small mirror on this diaphragm. Arrange laser torch in such a way that the light beam from it is incident on this mirror. Make suitable adjustments so that the reflected beam falls on the screen.

Now try to produce sound by hitting the balloon diaphragm with a thin mid rib of a coconut leaf. Observe the light incident on the screen after its reflection from the mirror.

Sound is produced due to the vibration of bodies and it can also make objects vibrate. Place a small loudspeaker inside a pipe on which a balloon is fastened and try to play music through it from a music player. You will see the light on the screen dancing in accordance with the music.

You can see on the wall the vibrating movement of the balloon through the movement of the laser beam reflected from the mirror, can't you?

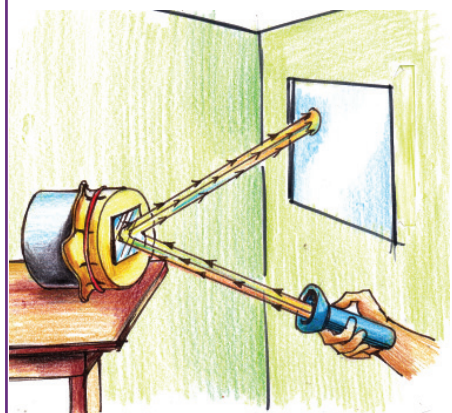

Let's do one more experiment.

Fix one end of a hacksaw blade on a table and set the free end into vibration. Is the frequency of vibration of the hacksaw blade greater than or less than the frequency of the simple pendulum? What is your experience?

The sound produced by the simple pendulum cannot be heard because the frequency is low. But on vibrating a hacksaw blade, its frequency being high, the sound can be heard. There occurs a difference in sound in accordance with the increase in frequency. Set two tuning forks of different frequencies into vibration and listen to the sounds. Notice the frequency marked on each of them. Don't you experience the difference in the sounds produced by them?

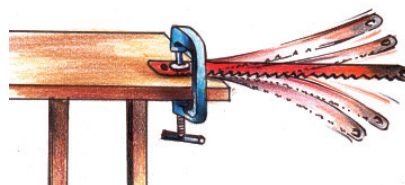

Fig. 19.7

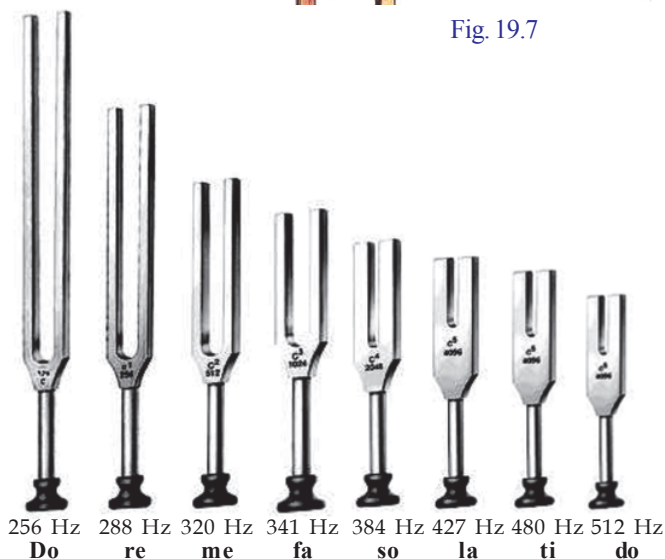

Fig. 19.8

When a body is set into vibration, it vibrates with a particular frequency of its own. This frequency is its natural frequency.

When the steel tumbler, hacksaw blade, tuning forks etc., were set into vibration, the reason for the difference in sounds that emerged from them was due to the difference in their natural frequencies.

If the frequency of sound produced by a table when tapped with a pen is 200 Hz, what will its natural frequency be?

What are the reasons for the differences in the natural frequencies of different objects?

Observe figure 19.9.

We use at home, instruments made of metal pipes for producing sound and for decorative purposes.

- Do all pipes make sounds of the same kind?
- What difference do you observe between the pipes?
- Make an instrument using PVC pipes instead of metal pipes as shown in figure 19.9 and try to produce



Fig. 19.9

sounds. Is the sound the same as the one produced by metal pipes? What could be the reason for the change in sound?

- Stretch a rubber band as in figure 19.10. Set the rubber band into vibration and listen to the sound. Listen to the sound again by changing the tension of the rubber band. Do you detect any change in the sound you listen to?
- Fix diaphragms made of balloons of the same tension on one end each of two pipes of different diameters. Beat them evenly with a thin mid rib of a coconut leaf.

Why is the change in sound experienced? Discuss in relation to the area of the diaphragm.

- Stretch two copper wires of the same length and of different thickness under the same tension and try to make sounds by plucking them. Do you experience any difference in the sounds produced?

From the experiments you have done, list out the factors that influence the natural frequency of a body.

- Nature of the body
-

Characteristics of sound - pitch and loudness

Have you ever noticed the difference in male and female voices? Which one is sharper?

The sharpness of the sound heard is the pitch. It depends on the frequency of sound.

Analyse the table in relation to the sharpness or pitch of the sound and fill in the blanks.

Sound pairs	High pitch	Low pitch
Male voice, Female voice	Female voice	Male voice
Cuckoo's cry, lion's roar		

Table 19.4

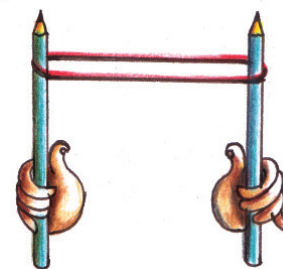

Fig. 19.10

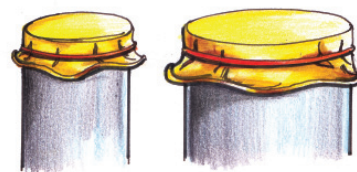

Fig. 19.11

The Buzzing Mosquito!



The buzzing sound of mosquitoes and bees is the sound produced by the vibration of their wings. The wings of the mosquitoes vibrate at an approximate frequency of 500 Hz and that of the honey bees at 300 Hz. It is these vibrations that we hear as a slight buzzing or humming sound.

Crickets produce sounds when special parts in their wings rub against each other. These sounds are of high frequency. It is said that the Silent Valley takes its name from the absence of crickets there.

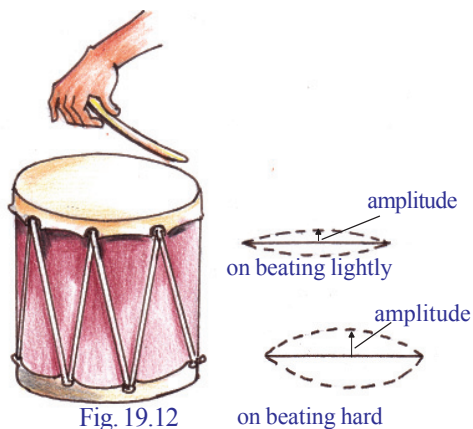

Fig. 19.12



Male and female voices

The length of the vocal cords of a man increases with maturity whereas no appreciable change occurs in the vocal cords of women. Frequency of sound decreases as the length of the vocal cord increases. As frequency and pitch are related to each other, the sharpness of male voice would be less.

Music & Noise

Sound produced with regular vibrations and which is pleasant to hear is music and the one produced with irregular vibration and which is unpleasant to hear is noise.

Sapthaswarangal

Another word used in relation to the word pitch in music is sruthi. Given below is a table showing the sapthaswarangal and their corresponding frequencies.

Do	re	me	fa	so	la	ti
256	288	320	341	384	427	480
Hz	Hz	Hz	Hz	Hz	Hz	Hz

You are familiar with musical instruments such as *chenda* or *maddhalam*. You would have noticed that the sound that is produced from them varies when they are beaten. This is due to the difference in their property known as loudness of sound.

Is the sound experienced the same when your friend whispers to you and when he/she talks to you normally?

Observe figure 19.12.

- In which context would the sound have the maximum loudness? (on beating lightly/on beating hard)
- In which context would the amplitude of vibration be more?
On beating lightly/on beating hard.
- If so, what is the relation between loudness and amplitude of vibration?

Loudness is the measure of audibility of a person. This depends mainly on the amplitude of vibration and the sensory ability of the ear. The unit of loudness is decibel (dB). This is measured using a device named decibel meter.

Propagation of sound

How does sound from different sound sources that reach us?

Observe the figure.



Why do the astronauts use radio devices to communicate with one another?



Let's us do an experiment

Take some water in a flask as shown in figure 19.13. Close the flask in such a way that a bell tied to the end of a thin metal rod is inside the flask. Shake the flask.

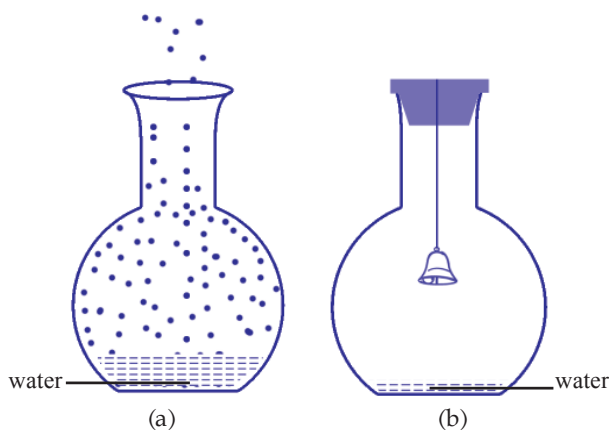

Fig. 19.13

Do you hear any sound? Remove the cork and boil the water in it till the flask is filled with steam. After this close the flask with the cork containing the bell. Pour cold water over the flask.

Now what happens to the steam inside the flask? What happens to the quantity of air inside the flask?

Now shake the flask. What change is experienced in the loudness of the bell?

Discuss the reason for this change and write down the inference.

You would have understood that the loudness of the sound heard is reduced because the quantity of air inside the flask is reduced. If so, would you be able to hear the sound on removing the air completely?

A medium is necessary for the propagation of sound. Through which medium does the sound of your friend reach your ears?

A medium is necessary for sound to travel.

Alexander Graham Bell

Alexander Graham Bell was born on 3 March 1847 at Edinburgh in Scotland. Both his mother and wife were deaf. On 9 October 1876 Alexander Graham Bell presented the first telephone to the world by speaking to his friend and assistant, Watson through a cable wire from Cambridge to Boston covering a distance of two kilometres. He died on 2 August 1922 at the age of 75.

It is to honour Alexander Graham Bell that the unit of loudness is named 'bel'. Decibel (dB) is a smaller measure of the unit 'bel', that is one tenth of a 'bel'.

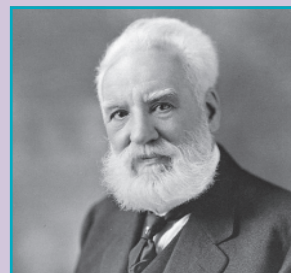

Sounds	Approximate loudness in dB
Sound that hurts the ear	Above 120
A jet engine 100 m away	110-140
Road with heavy traffic	80-90
Car	60-80
Normal talk	40-60
Murmur of leaves	10

Table 19.5

Now you may be able to explain why astronauts use radio devices for communication.

Is it only through air that sound travels? Let's see. Press your ear against one end of the desk. Let your friend scratch the other end of the desk with his nail. Can you hear the sound of scratching? In this case, through which main medium did the sound reach your ear?

Try to do another experiment. Take a bucket filled with water. Hold a steel vessel immersed inside the water and tap on it with a spoon. Can't you hear the tapping sound?

Hold a steel spoon in your mouth between the teeth. Cover both your ears tightly with your fingers. Let your friend gently tap on the spoon. Do you hear any sound?

Write down your inferences from the experiments you have done.

You would have understood that sound can propagate not only through air but also through other materials.

Hearing

You might have understood that sound is produced due to vibration and requires a medium for its propagation. But how do we sense sound? Which sense organ helps us here?



Fig. 19.14



Fig. 19.15

- What would be the result if one or more parts of the ear get damaged?

Damage to the ear can occur either at birth or at any time later in life. Such people experience many difficulties due to the loss of hearing. Discuss the difficulties they face on the basis of the following indicators.

- Communication
- Ability to speak
- Vulnerability to danger
-
-

How should we approach people with impaired hearing? Discuss on the basis of the following indicators and present your ideas in the school assembly.

- Deal with empathy.
- Include them in your work and play.
- Ensure their participation and give due consideration to them in all possible activities.
-
-

Limits of Audibility

Can a person with normal audibility hear all sounds?

Do you know?

- *The sound of the Galton whistle used to call dogs cannot be heard by human beings.*
- *Prior to natural calamities, birds and animals exhibit unusual behaviour.*
- *Bats can travel easily even in darkness.*

Sounds having frequencies greater than 100000 Hz occur in nature due to the vibration of bodies. We cannot hear sounds of all frequencies. It means there is a limit to the frequency of sound that can be heard by human beings. For a person with normal hearing



Ear and Sound

The sound waves that reach the external ear pass through the ear canal and strike the eardrum. This causes vibration on the eardrum. The vibration of the eardrum sets a series of bones into vibration. The vibration in the series of bones is transmitted to the cochlea of the inner ear through the oval window. Cochlea is about 3 cm in length and is in the shape of a snail. The vibration spreads to the cochlear fluid called the endolymph. The vibration stimulates thousands of nerve cells in the cochlea and impulses are formed. When these impulses reach the brain through the nerves, we can sense the sound.

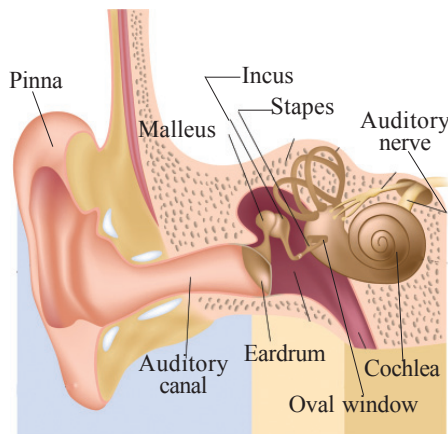



Hearing Aid

Hearing aid is an electronic instrument used to provide the sensation of hearing for people with hearing problems. Hearing aids are available in different types and sizes. They have three main parts:

Microphone - It converts sound energy into electrical signals.

Amplifier - It enhances (amplifies) the electrical signals.

Loudspeaker - It converts the amplified electrical signals into loud sounds and sends them to the eardrum.

A battery is also included to provide electricity needed for the working of the hearing aid.

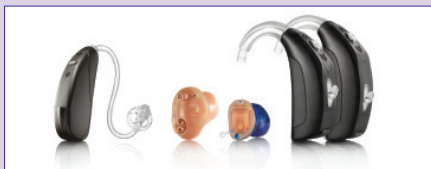

Range of Audibility

Approximate frequency (Hz)

	Lowest	Greatest
1. Dog	67	45,000
2. Cat	45	64,000
3. Cow	23	35,000
4. Horse	55	33,500
5. Rat	1000	91,000
6. Bat	2000	1,23,000
7. Elephant	16	12,000
8. Goldfish	20	3,000
9. Hen	125	2000

capacity, the lower limit of audibility is about 20 Hz and the higher limit of audibility is about 20,000 Hz. This limit varies from person to person.

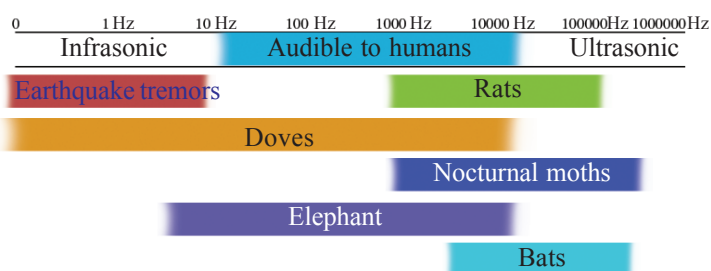

Observe the figure given below.

Sounds with frequency of less than 20 Hz are called infrasonics and those with a frequency greater than 20000 Hz are ultrasonics.

- The frequency of sound produced from a Galton whistle is about 30000 Hz. Write down the reason why human beings are unable to hear this sound while dogs can.
- Bats can produce and hear ultrasonic waves. Discuss how they travel easily at night and



write down your inferences.

- When earthquakes occur infrasonic waves are produced. Can we hear this? But certain animals respond to it. Why?

Uses of ultrasonic waves

- Ultrasonic waves are used in the instrument SONAR (Sound Navigation and Ranging) to



measure the depth of the ocean.

- Ultrasonic waves are also used in the medical field for diagnosis and treatment.

Noise pollution

Let's eradicate noise pollution
with public support.
District Collector

You would have read the statement of the District Collector. What do you understand by noise pollution? What is your response to this statement made by the collector?

Production of sound in a manner unhealthy to human being is noise pollution.

Let's read another statement.

"Kerala is one of the places with the highest noise pollution in the world. Noise affects not only our physical health but also our mental and emotional levels. It leads to high blood pressure, deafness, asthma and learning disability."

- What are the disadvantages of noise pollution?
- What can we do to reduce noise pollution?

Reducing noise pollution

- Use of air horns in vehicles is prohibited by law.
- Box type loudspeakers must be used in place of horn type loud speakers.
- Ensure that silencers in vehicles work properly.
- Plant as many trees as possible to minimise noise pollution. Trees can reduce loudness of sound by absorbing sound energy.
- Loudspeakers should not be used in public places before 6 am and after 10 pm
- Do not make sounds above 50 dB in the premises of hospitals, educational institutions etc.



Gather more information on noise pollution and the measures to reduce it.

Present your findings in the class.



Significant learning outcomes

The learner can

- explain that sound is produced by vibration and identify the factors which are required for the perception of sound.
- identify and explain the characteristics of sound such as frequency, pitch and loudness.
- explain that sound requires a material medium for propagation and that it travels through different media.
- identify the importance of the sense organ 'ear' and engage in activities to help people with hearing impairments.
- distinguish between infrasonic and ultrasonic waves and explain them effectively.
- engage in activities to reduce noise pollution.



Let us assess

1. If a tuning fork vibrates 480 times in one second, what would be its natural frequency?
2. If a simple pendulum oscillates 10 times in 10 second, what would be its frequency?
3. What are the factors influencing the natural frequency of a body?
4. The frequencies of certain tuning forks are given below. Find out which among these have the highest and the smallest pitches.
(256 Hz, 512 Hz, 480 Hz, 288 Hz)
5. In the sources of sound given below, vibration in which main part produces sound?
a. Chenda b. Flute c. Vocal cord

6. Design an activity to prove that sound can be propagated even through solid substances.
7. Say whether the following statements given below are true or false.
If false, rewrite it by making necessary changes.
 - (a) Sound cannot travel through vacuum.
 - (b) When frequency of sound increases, pitch decreases.
8. 'Bats can catch prey even in the dark'. Do you agree with this statement? Explain your inference.
9. How do human beings contribute to noise pollution?
10. Which unit represents loudness?
(Hz, m/s, dB, W)



Extended Activities

1. Make a 'toy telephone' using paper cups and thread and talk to each other.
2. Listen to the sounds in nature, identify natural sources of sound and understand the vibrating parts in them. Tabulate your findings appropriately.
3. Make different types of sound-producing toys and exhibit them in your class.
4. Prepare a table containing man-made and harmfully loud sources of sound.
5. Conduct an interview with a legal expert on the laws related to noise pollution. Present a report in the class.
6. Prepare posters and exhibit them to spread awareness about the harmful effects of noise pollution.



Static Electricity



Observe the picture. It is a very rare photograph taken at Moro Rock. This photo of the two brothers was taken by their sister from a distance. Immediately after the photograph was taken, the elder child in the photograph had fallen down, struck by lightning.

Why did the strands of the children's hair stand up?

Let's do some experiments.

Rub a plastic pen or scale on dry hair and bring it near pieces of paper. What do you observe?



Fig. 20.2

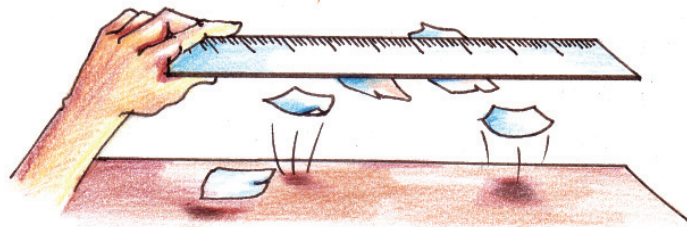

Fig. 20.1

Similarly, rub a plastic scale well against your hair and bring it near a gentle stream of water from a burette. What do you observe? Write down your observation.

What is the inference from these experiments?

When certain substances are rubbed against each other, they are able to attract other substances.

Try rubbing the following bodies against each other: Inflated balloon, ebonite rod, glass rod, P V C pipe, comb, silk, wool, polyester, dry hair and steel spoon.

Record your findings in Table 20.1.

Sl. No.	Bodies used for rubbing		Attracts (✓) or does not attract (×) small pieces of paper
1	Glass rod	Silk	✓
2.	Ebonite	Wool	✓
3.	Steel Spoon	Polyester	×
4.			

Table 20.1

What do you infer from these experiments?

Only a compatible pair of bodies, when rubbed, have the ability to attract other bodies.

How do the bodies get the ability to attract other bodies on rubbing?

Matter is made up of molecules. Molecules are made by joining atoms.

Proton, neutron and electron are the subatomic particles in an atom. Neutron does not possess any charge. Protons have positive charge and electrons have negative charge. In any atom, the number of protons and electrons are equal. So an atom is electrically neutral.

- If an electron is lost from an atom, what would be the resulting charge of the atom?
- What if an electron is received by an atom?

An atom gets positive charge on losing electron and negative charge on receiving electron.

When certain bodies are rubbed against one another, electron transfer take place. When electron is transferred from one body to another

- Which body gets positive charge ?
- Which one gets negative charge?

Complete the table given below.

Pair of bodies used for rubbing and the electron transfer between them		Charge received	
Pair of bodies	Electron transfer	Positive	Negative
Glass rod, silk	Glass rod loses electrons	Glass rod	Silk
Ebonite, wool	Wool loses electrons		
Rubber rod, wool		Wool	

Table 20.2

Electrification or charging is the process of converting an object into an electrically charged one.

If the electric charge produced in an object remains at the same place in it, it is called static electricity.

Can metals be electrically charged through friction?

Let's examine

Rub a copper rod against wool and see if it attracts other objects. Now rub it against silk and then polyester and examine the same. Repeat the process with a hacksaw blade and a steel spoon.

What is your inference?

Though metal surface is electrified on friction, the charge is spread immediately to other parts as it is a conductor. So static electric charge is not formed on metals.

Is it attraction alone that takes place between charged bodies?

What do you observe?

Let's do the following.

Suspend two inflated balloons in such a way that they touch each other. Place a flannel between them and rub the two balloons on it. Observe the balloons after removing the flannel.

Rub with silk a glass rod suspended on a thread and bring another charged glass rod near the suspended one. What do you observe?

Discuss the reason for repulsion between charged glass rods and charged balloons and write down your inference. You would have realised that like charges repel each other.

Let's do another experiment.

Rub with silk a suspended glass rod and bring the rubbed part of the silk near the glass rod.

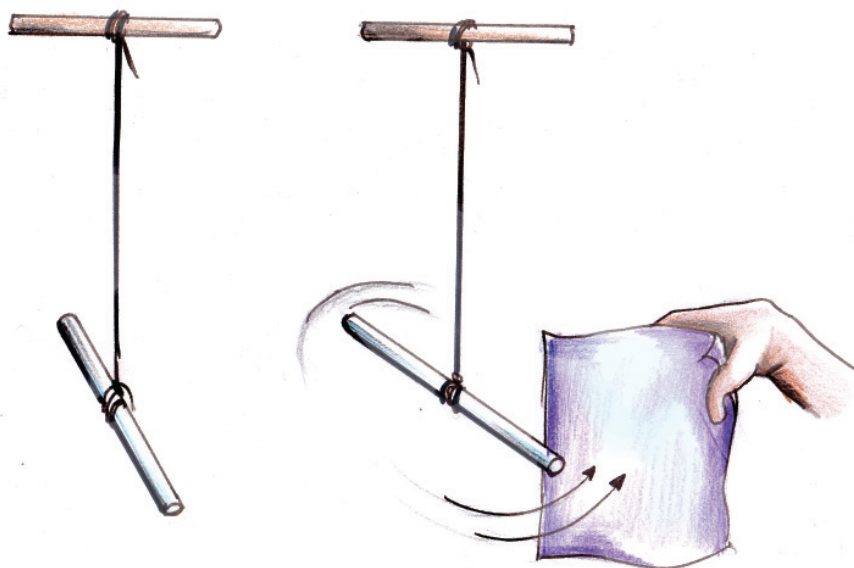

Fig 20.2

In the science diary, note down your inferences on the properties attraction and repulsion of electric charges.

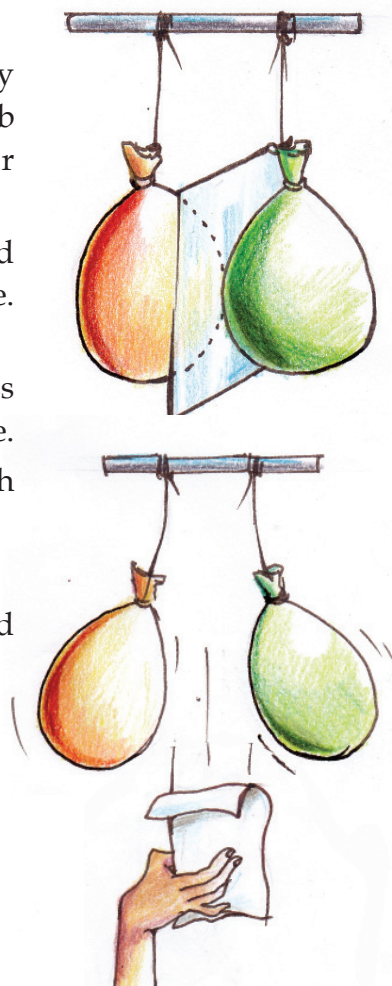

Fig 20.3



See the portion 'Balloons and Static Electricity' in PhET in Edubuntu

Properties of Electric Charges

- Charged body attracts uncharged bodies
- Unlike charges attract each other
- Like charges repel each other.

If two bodies attract each other we cannot say with certainty that both of them possess charge. But if bodies repel each other, it is sure that both the bodies possess like charges. So repulsion, and not attraction, is the means by which we confirm whether bodies possess charge or not.

*The unit of electric charge is coulomb.
Charge is a scalar quantity.*

How do we know that a body is charged?

Electroscope is the instrument to know the presence of static electric charge. Write down the parts of electroscope by analysing figure 20.5.

Let's construct an electroscope.

Materials required: One transparent plastic bottle, a copper wire, cardboard, aluminium foil (used for packing food items), straw, cellotape.

Method of construction

Cut the cardboard in such a way that it covers the bottle. Make a hole at the centre of the cardboard as shown in the figure 20.6. Fix the straw by inserting some portion of it through the hole. Pass the copper wire through the straw. Bend both ends of the wire.



Fig. 20.5

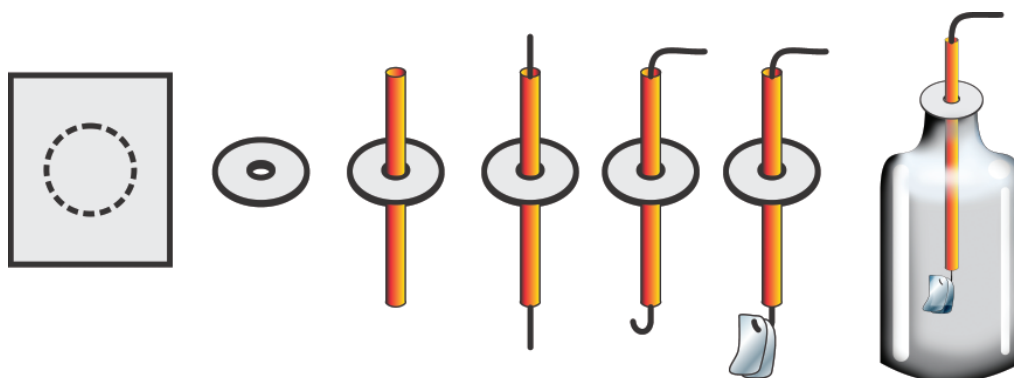

Fig. 20.6

Hook two aluminium foil pieces of the same size as shown in the figure. Fix the cardboard to the bottle using cellotape.

Touch the top end of the electroscope with a charged glass rod. What do you observe? What may be the reason for the divergence of the leaves?

How can a charged electroscope be neutralised? For this, select the suitable one of those given below and put a tick mark (✓) wherever appropriate.

- Give an equal amount of the opposite charge
- Give an equal amount of the same charge
- Touch with a chargeless ebonite rod
- Connect the free end of a metallic wire having one end buried deep in the earth

The activity to neutralise the charge on a body is known as discharging.

Earthing

Connecting a body to the earth using a metallic conductor is known as earthing. On earthing a charged body, electrons pass from the earth to the body or from the body to the earth to neutralise the charge on the body completely. The earth gives or receives electrons at any time and in any quantity. So the earth is sometimes referred to as an electron bank. The symbol of earthing is .

- If a positively charged body is earthed, in which direction does the electron flow?
- What will happen if a charged ebonite rod is earthed? Do bodies receive charge only through friction?

Electrostatic induction

Let's do an activity.

Touch a suspended pith ball with a charged PVC pipe as shown in figure 20.7 (a).

What do you observe?

If a body receives charge by its contact with another charged body, it is known as charging by conduction.

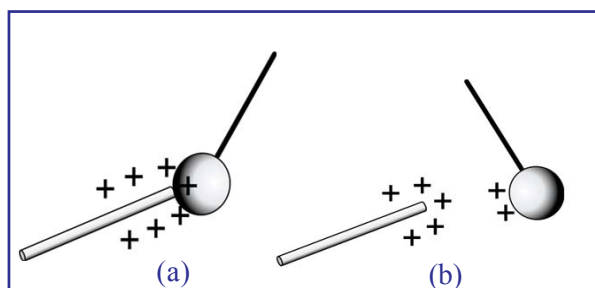

Fig 20.7

In charging by conduction, both bodies would have the same type of charge. Now you know why the pith ball remains repelled after being touched (Fig. 20.7 (b)).

Let's do another experiment. Bring a negatively charged rod near the end of the metallic wire of an electroscope (Fig. 20.8 (a)). The leaves remain separated, don't they? How did the leaves get electric charge?

On bringing the negatively charged rod near the wire of an electroscope, would the electrons at that part of the wire be attracted or repelled?

In which direction would the repelled electrons move?

Find out on the basis of figure 20.8 (a).

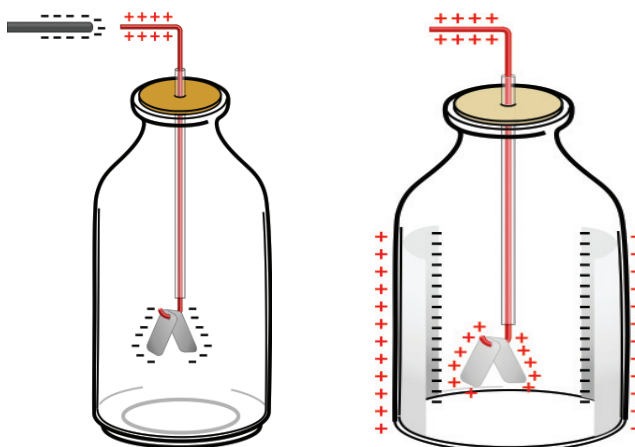

Fig 20.8 (a)

Fig 20.8 (b)

What charge is present on the part where the electrons reach and on the part from where the electrons are removed?

What change could be observed in the electroscope on removing the charged rod? Write down your findings in the science diary by analysing figure 20.8 (b).

What would be the reason for this change?

As the electrons are distributed to their previous positions, the charge received by the leaves is lost and the leaves come close to each other.

Picturise the method of formation of charge on an electroscope when a charged glass rod is brought near.

The redistribution of charges in a body as a result of the presence of another charged body is called electrostatic induction.

Can an electroscope be charged permanently by induction? Analysing the figures given below, note down your inferences in the science diary.

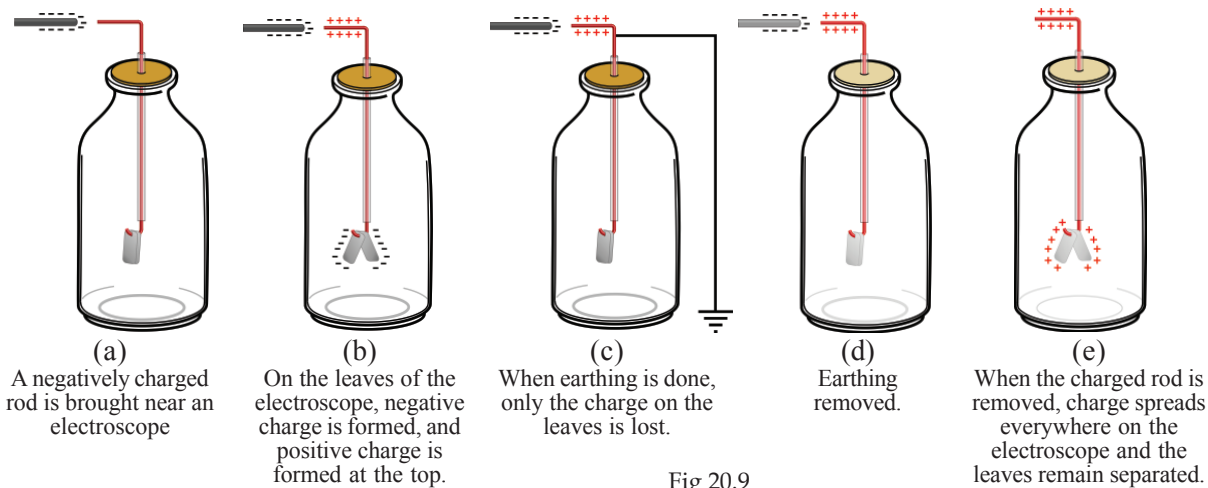

Fig 20.9

If an electroscope is charged by induction to retain the charge in it for a long interval of time, the charge formed would be the one opposite to that of the body used to charge it.

Write down in your science diary the method of charging an electroscope negatively by induction.

If an electroscope is kept charged for a long time, we can see that its leaves come close to each other slowly. But what happens if the bottom of the bottle is cut and an aluminium foil is stuck to the inside of the bottle as shown in the figure 20.10?

Which charge is induced on the inner surface of the foil?

What about the charge induced on the outer surface of the foil? Find out by analysing figure 20.10.

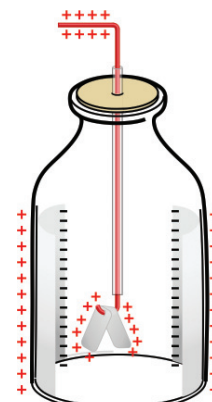

Fig 20.10

When a conductor is placed near a charged body, opposite charge would be induced on the surface of the conductor facing the charged body. The charge on the electroscope stays for a long time due to the attraction of these opposite charges. A capacitor is constructed on the basis of this principle.

Capacitor

As shown in figure 20.11 (a), place the metal plate B near the positively charged metal plate A.

Which charge would be induced on the surface of the plate B facing A? What happens to the surface which is away from A?

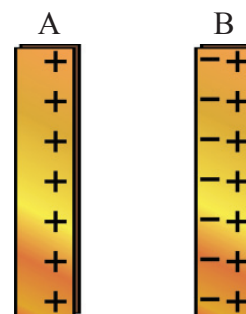

Fig 20.11 (a)

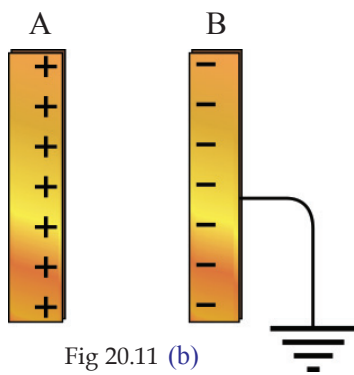

Fig 20.11 (b)

If the plate B is earthed as shown in figure 20.11(b), which would be the charge remaining in the plate?

With this arrangement, electric charge can be stored or retained for a long time. This is because of the electric field formed between them. The device which can store electric charge in this way is called a capacitor.

In order to increase the ability of storing electricity in a capacitor with plates of fixed area, suitable insulators are used between the plates. Such insulators are called dielectrics. Paper, air, polyester etc., can be used as dielectrics. Capacitors are usually known by the name of the dielectrics used in them. The ability of a capacitor to store charge is known as capacitance and its unit is farad (F).

$$1 \text{ F} = 10^6 \mu\text{F} \text{ (microfarad)}$$

$$1 \text{ F} = 10^{12} \text{ PF (picofarad)}$$



Different types of capacitors

Fig. 20.12

Distribution of electric charge

When a metallic substance is charged, how is its charge distributed? Charged metallic substances of different shapes are given in the figure below. The dotted lines seen in the figures indicate the distribution of charges. Record your findings by observing the figures.

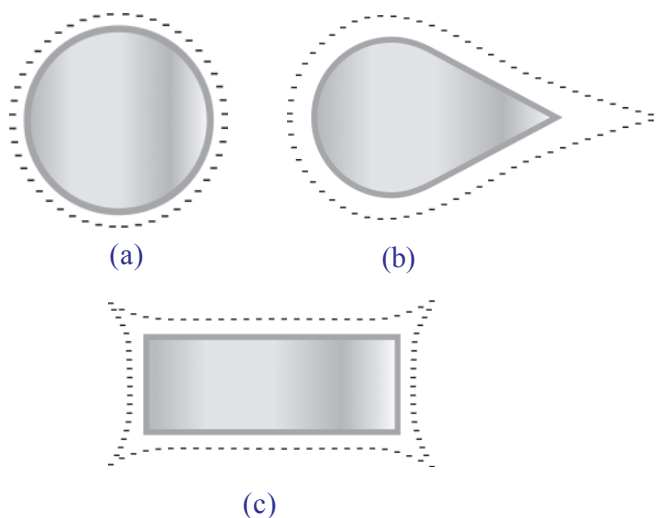

Fig. 20.13

*The charge distributed in a conductor would be only on its surface.
The amount of charge would be more at the pointed ends.*



Fig. 20.14

Thunder and lightning

On certain occasions, during rainy season, thunder and lightning may have frightened you. Have you ever wondered how lightning occurs?

Lightning is the electric discharge between charged clouds in the atmosphere or between charged clouds and the earth.

Lightning conductor



Fig. 20.15

Have you ever seen the device used for protection from lightning?

Let's see how a lightning conductor works. Lightning conductor is earthed well. Haven't you learnt that, on certain occasions, electric charge accumulates in the clouds?



Thunder and lightning

There are many theories regarding the accumulation of charge in the clouds. An acceptable explanation among them is this:

The upper part of clouds, which is at a very high altitude from the surface of the earth, gets cooled to form ice. When strong winds blow, such particles exchange electrons by friction. The particles which gain electrons remain at the bottom and those which lose electrons remain at the top. In this way hundreds of coulomb charge are accumulated.

Such a huge amount of charge is enough to change the air, which is an insulator, into a conductor. Light is produced due to the flow of thousands of ampere current through air in a very short time. This is lightning. At the same time, thunder is the trembling that occurs due to the limitless expansion of air at a very high temperature.

Benjamin Franklin 1706 - 1790



Benjamin Franklin was born on 17 January 1706 at Boston in America. He named the electric charges as positive and negative. He was the Vice President of Philadelphia in the USA. It was his well-known experiment of kite flying which led to the inference that lightning is flow of charges.



When a large quantity of negative charge is accumulated in clouds, large amount of positive charge is produced at the pointed ends of the lightning conductor. This is because many electrons flow to the earth from the lightning conductor through the earthed part. Electric field is produced by the presence of this charge at the pointed ends. This neutralises the negative charge from the clouds. Through this, the possibility of lightning is eliminated.

What if positive charge is accumulated in clouds?

In which way would the lightning conductor work then?

Write it down in your science diary.

If positive charge gets accumulated in clouds, negative charge would be induced at the pointed ends of the lightning conductor. At the same time, positive charge would accumulate at the bottom of the lightning conductor. The charge at the pointed ends creates an electric field around the pointed ends. This field neutralises the electric charge that comes within its boundary from the clouds.

The lightning conductor is earthed well in order to supply or receive sufficient quantity of electrons from the bottom portion of it.

Now you can explain why the hair of the child in the photograph given at the beginning of this chapter stands up vertically and also why soon afterwards lightning had struck him.

The electric charge accumulated in the layers of clouds induced opposite charge in the body of the child. This attracted the strands of hair towards the cloud layers. This is what is seen in the picture. The lightning which followed struck the child down.

How to protect ourselves when there is lightning:

- Do not operate electrical equipments.
- Do not lean on the wall of the house.
- Do not stand holding window bars or grills.

- Do not stand beneath tall trees.
- Do not take shelter under isolated trees.

What other methods can be adopted to protect ourselves from lightning?

Gather more information.

Let's see the primary steps to be adopted when a person is struck by lightning.

A person struck by lightning should be made to lie in a place where there is good air circulation. In order to prevent blood clotting, keep the body warm by massaging. Give artificial respiration to enable continued breathing. Press strongly on the chest at regular intervals to maintain the heart beat. The person must be taken to a hospital as early as possible.



Significant learning outcomes

The learner can

- explain how static electric charge is produced on rubbing two suitable pair of substances against each other.
- explain why static electric charge is not produced by rubbing metals.
- engage in activities related to electric charges.
- explain what earthing, charging by contact, charging by induction and principle of capacitors are.
- explain the working of lightning conductor and use methods to protect oneself from lightning in daily life.



Let us assess

1. From which one to which does electronic transfer occur when the pair of substances given below are rubbed against each other?
 - (a) Glass rod - Silk cloth
 - (b) Ebonite - Wool

2. Among the substances given below, which cannot be electrified by friction? Why?
Amber, Plastic, Hacksaw blade, PVC pipe.
3. Lightning conductors, which are not properly earthed, produce disaster rather than benefit. Justify this statement.
4. What are the precautions to be taken for protecting ourselves from lightning?
5. How would you convert a copper plate kept in an electroscope into an arrangement for storing charge for a long time, through induction?



Extended Activities

1. Rub different substances that are present in the surroundings against each other and find out the type of charges they receive.
2. Make an electroscope and operate it.
3. Examine different types of capacitors (abandoned) and find out the dielectrics used in them.
4. Find out how earthing is effectively done on lightning conductors and how their maintenance is carried out.

